

We share our experience to give you the **best Support**



COOKBOOK

CONTENT

1 GENERAL INFORMATION	2		
1.1 Software	2	4.2 Print curing	10
1.2 Rule regarding the power supply	2	4.3 Before refilling the white ink	10
1.3 Environmental printing conditions	2	4.4 Ink refill	11
1.4 Storage of liquids	3	4.5 Ink tank calibration	12
1.5 Control Panel	4	4.6 Cleaning solution refill	13
2 BEFORE PRINTING	4	4.7 Event of power failure	14
2.1 Visual inspection	4	4.8 Cleaning / replacing of maintenance parts	14
2.2 Daily nozzle test	5	5 MAINTENANCES	16
2.4 Pretreatment	7	5.1 Weekly maintenance	16
2.5 Platen adjustment	7	5.2 Monthly maintenance	19
3 HOW TO PRINT	9	5.3 Preventive maintenance	20
4 DURING THE DAILY WORK	9	5.4 Extract a logfile for support	20
4.1 The platen sensors	9	5.5 When not using the printer	21
		6 ORDER LISTS	22

1 GENERAL INFORMATION

The printer should only be used by **operators** who are appropriately **trained** in its safe operation. The printer is **not suitable** for use in places where **children** are present.

1.1 SOFTWARE

Always make sure that you use the latest software for your **GTXpro Bulk**.

You find the latest versions here:

<https://base.brother.digital/driver-firmware/gtxpro-gtxpro-bulk/>

<https://base.brother.digital/software-tools/>

1.2 IMPORTANT RULE REGARDING THE POWER SUPPLY

The **GTXpro Bulk** should always be left with power ON, also when it is not in use.

Power is needed to perform the recirculation of the white ink every day. This process does not consume ink.

If the **GTXpro Bulk** is turned OFF for a long time it might get damaged.

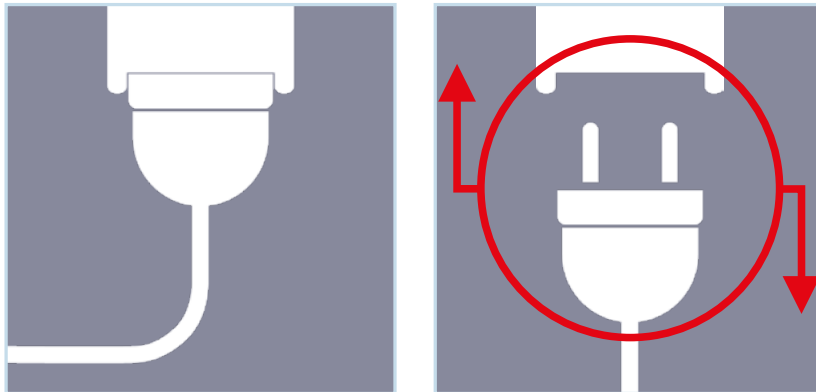

Only pull the plug in an emergency or when requested by a display message!

1.3 ENVIRONMENTAL PRINTING CONDITIONS

Mandatory temperature and air humidity for the best print result:

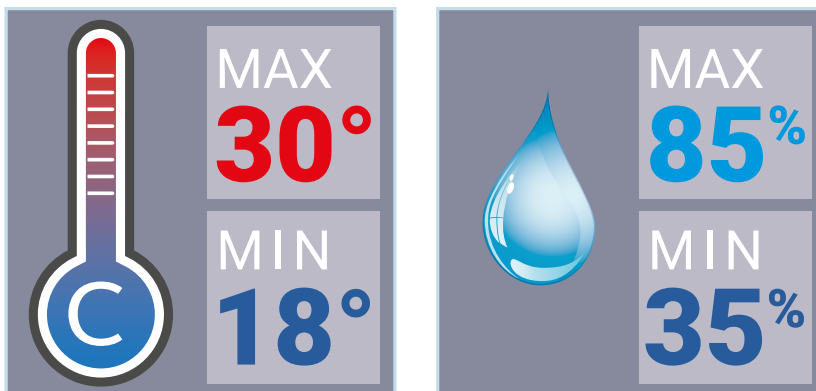

Required to keep your warranty for the printer!
Temperature & air humidity are recorded in the log file!



Please check the temperature and air humidity in the menu of the printer:

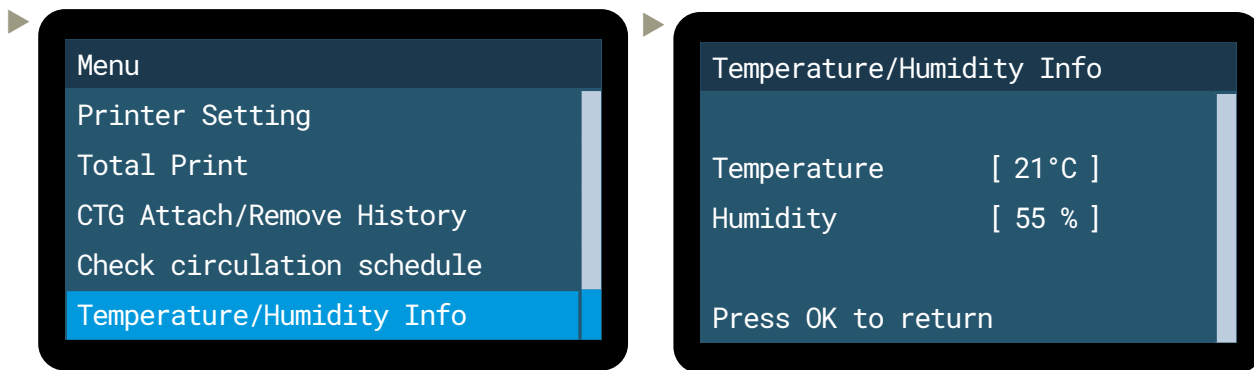

If temperature is too cold: The printer will switch automatically to “Low-Temp Mode” and reduce the speed. Raise the temperature of the printer’s environment.

If temperature is too high: Please turn down the temperature of the surrounding area of the printer.

If humidity is too low: The printer will perform auto-cleaning after every print if the humidity is lower than 35%.

Please install a humidifier in your workspace.

If humidity is too high: Please try to lower the humidity of the surrounding area of the printer.

Please always keep the temperature and humidity within the required ranges, otherwise the **GTXpro Bulk** might get damaged.

1.4 STORAGE OF THE LIQUIDS

The liquids should be stored at a temperature between minimum 0°C and maximum 40°C.

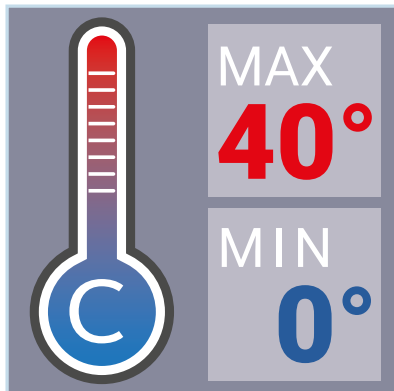

- ▶ Please turn over the **white ink canister** every week.
- ▶ Do not use inks or liquids with a temperature below 18° C or above 30° C .

1.5 EXPLANATION OF THE CONTROL PANEL



The display shows the current loaded print file with the used platen, the approximate ink consumption for it and the number of prints. In the lower left corner is the ink level shown. The light blue rectangles show the selection of print direction and resolution of the print. Warnings are displayed in yellow in the lower right corner. By pressing ▶, the display changes to the warning display on which the warning and the needed operations are indicated.





- A: Freely assignable speed dial button
- B: Button for platen moving
- C: Cancel button
- D: Print start
- MENU/OK:** Opens the menu and confirms actions.
- ▶: Cursor buttons for moving through the menus.
- E: The LEFT cursor button is the go back button.



- F: Power switch ON/OFF
- G: USB 3.0 Typ A port to load print files from an USB-stick.
- H: LAN port
- J: USB Typ B port

2 BEFORE PRINTING

2.1 VISUAL INSPECTION

- ▶ Regularly check all moving parts of the machine and look for ink leaks.
- ▶ Check the level in the waste ink tank and, if necessary, empty.
Dispose the accumulated waste according to your local regulations.
- ▶ Please follow all the instructions shown on the display.

When you see an "Error/Warning" yellow number press the "▶" key to know what you have to do to erase the Error/Warning.

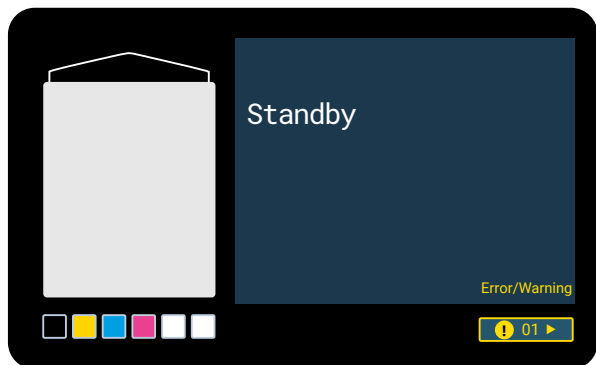

2.2 DAILY NOZZLE TEST

You have to perform a nozzle test for CMYK and white **every morning** before starting your production.

- ▶ For the test, the platen height has to be level **A**.
- ▶ For the CMYK test print, lay a sheet of white paper on the platen like shown in the picture.

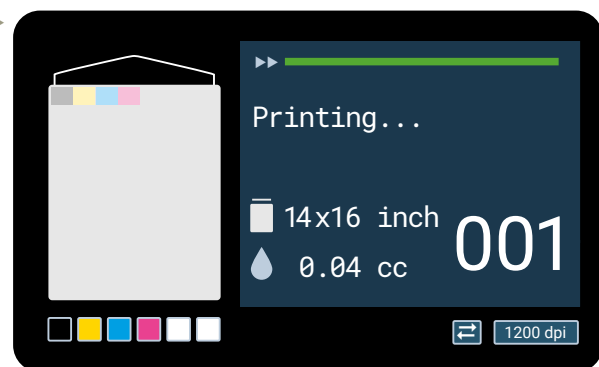
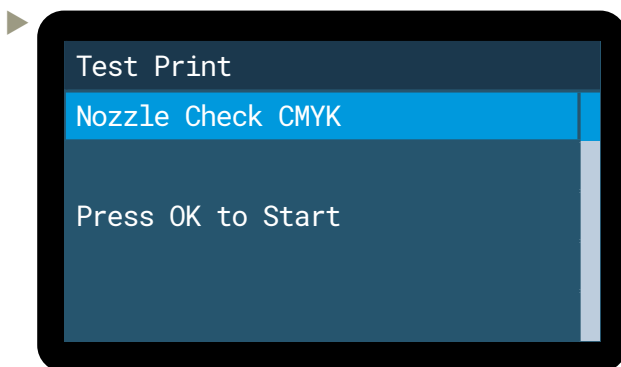
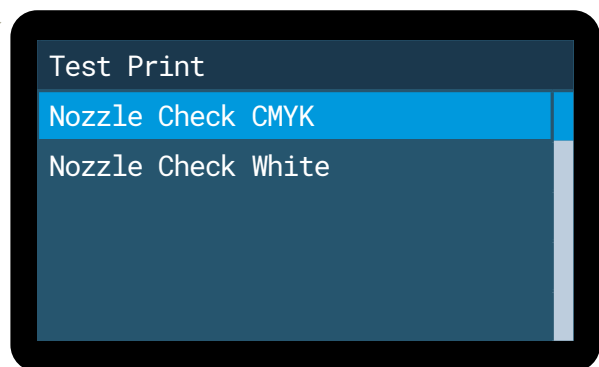
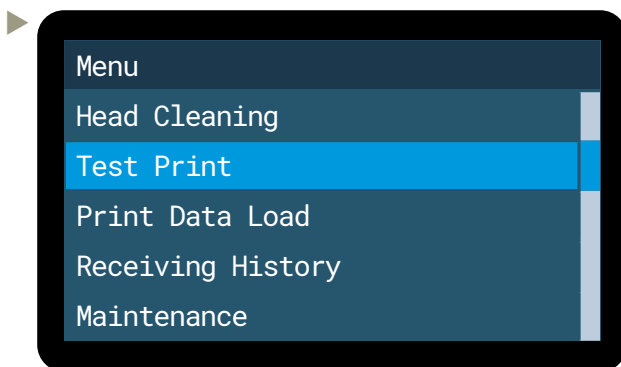
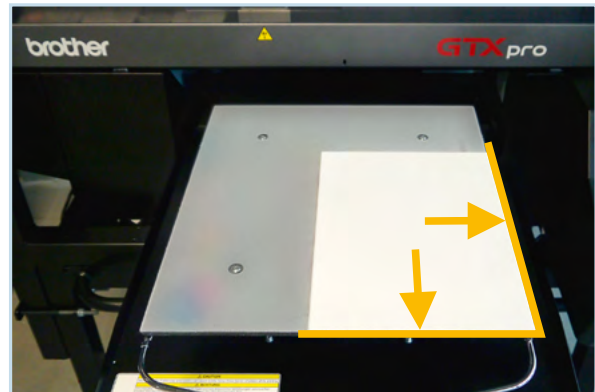

- ▶ For the WHITE test print, lay a sheet of black paper on the platen.

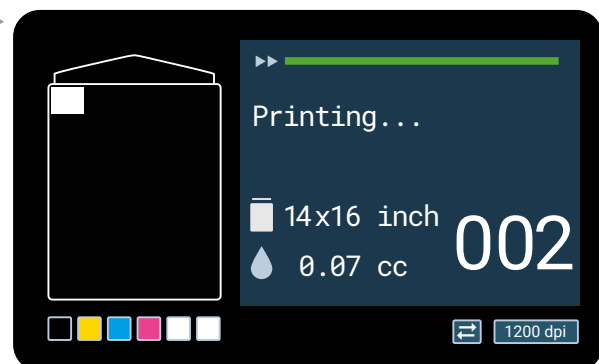
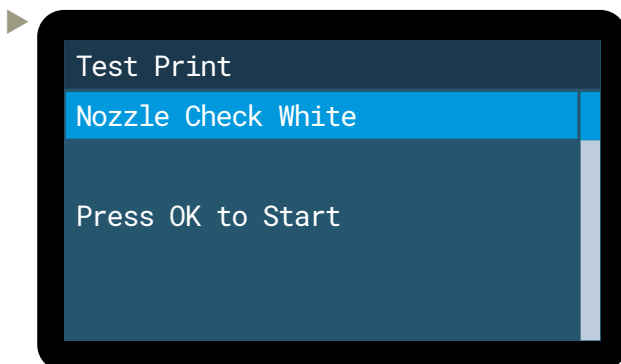

This is what the nozzle checks should look like:

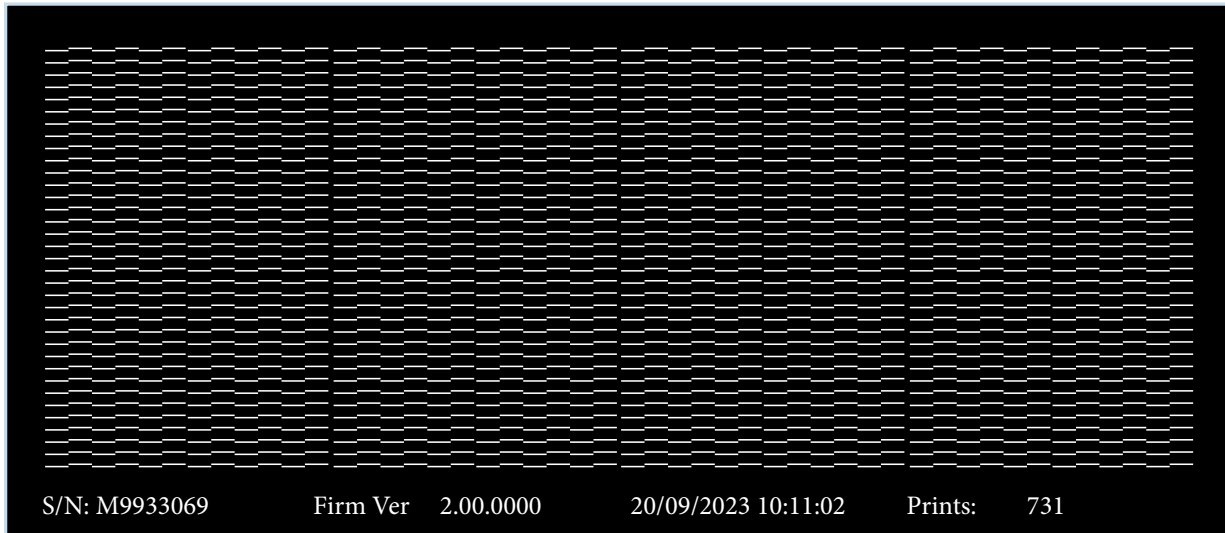
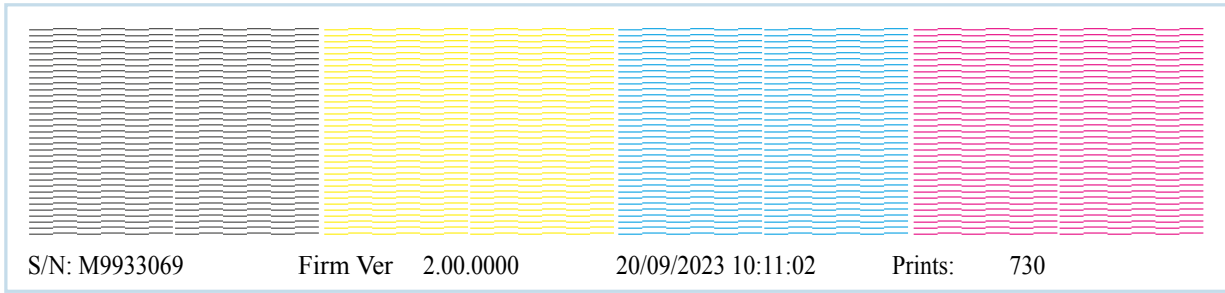

If not all nozzles are firing, start a cleaning of the affected printhead to open the clogged nozzles.



- ▶ If still more than 10 nozzles are missing, select super cleaning.
- ▶ Perform a nozzle test to check the result and perform another cleaning if the nozzles still do not spray.



2.3 PRETREATMENT

The following data are starting values for production.
Based on the results, self-optimised values could be used.

The mixing ratio for the ready-to-use pretreatment is about:

1 L concentrated pretreatment	+	2 L distilled water	= ready to use
---	---	-------------------------------	-----------------------

The mixing ratio might vary due to the type of garment.

Example of spray amount for a 14x16 inches (30x40 cm) surface:

T-Shirt color	Spray amount
DARK	~ 30 g
MEDIUM	~ 24-27 g
LIGHT	~ 14-17 g

Calibration of your PT-machine may be required.

Heat press settings for pretreatment drying:

~ 180°C	~ 5-5.5 bar	for 35 sec
~ 360°F	~ 75-80 PSI	

Use a greaseproof paper sheet (i.e. baking paper) to cover the pretreated garment and keep the heat press clean. Check the effective temperature of the heat press.

If you use VividBright the values change (Probably lower). Based on the results, self-optimised values could be used.

2.4 THE PLATEN ADJUSTMENT

Always keep the smallest distance between the printheads and the surface of the garment.
It is very important for the print result and the longevity of your printer.

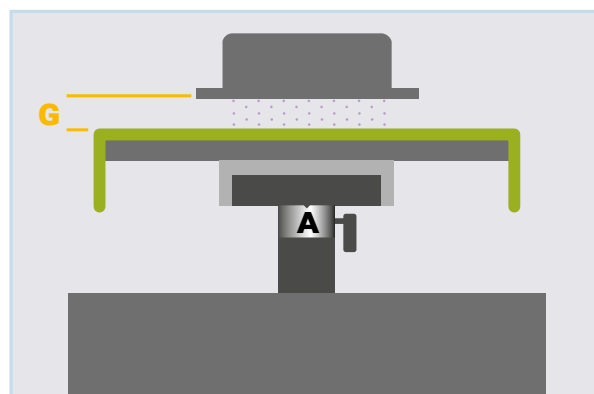

G: Distance of 3 mm (A) is best.

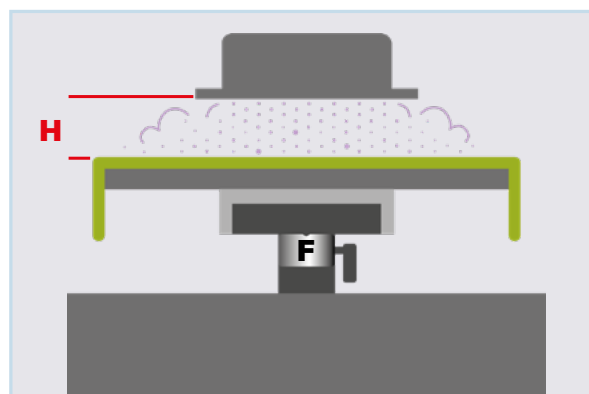

H: Distance of 10 mm (F) is here too much.



When a thicker textile is used, you need to adjust the platen's height in relation to the thickness of the textile. With the **GTXpro Bulk** you have three possibilities to adjust the platen:

1. Standard height adjustment

- ▶ **J:** Loosen the fixing lever.
- ▶ **K:** Move the height adjustment lever to the position you need.
- ▶ Tighten the fixing lever.

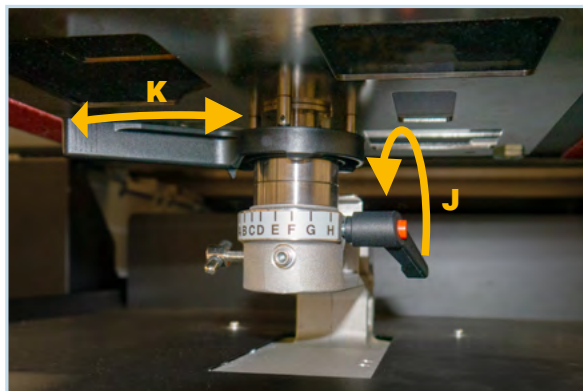

2. Height adjustment with the bearing and a collar for using XL platen

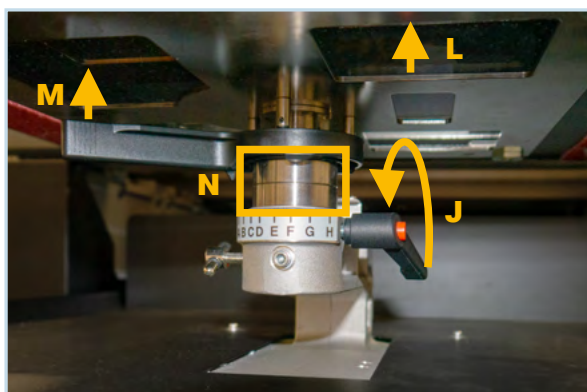

- ▶ **J:** Loosen the fixing lever.
- ▶ **L / M:** Carefully remove the platen and the height adjustment lever
- ▶ **N:** Remove or add a collar

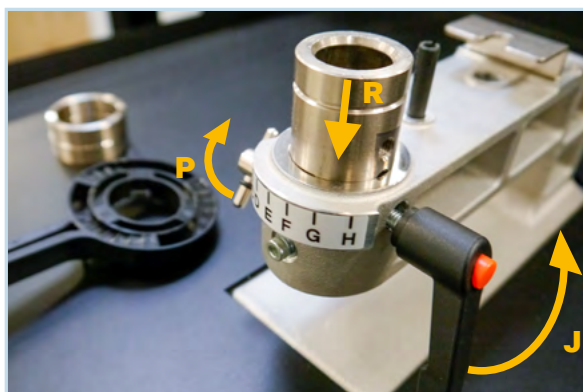

- ▶ **J / P:** Remove the platen and the height adjustment lever. Then remove the fixing lever (J) and loosen the knob (P).
- ▶ **R:** Move the bearing to a lower or higher level. Install the fixing lever in the desired thread. Tighten the fixing lever and the knob.

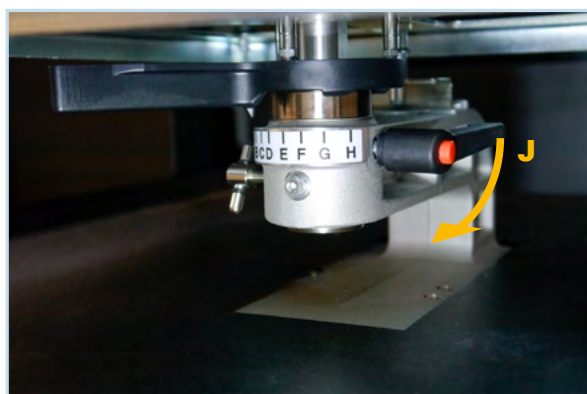

Install the desired platen and tighten the fixing lever.

Always tighten the knob (P) and the fixing lever (J) before printing.
After printing with a different platen height, please set it back to the standard height A.

If you have to print on hem and seams, go for **UNI-directional printing** to keep the quality level.



3 HOW TO PRINT

You can find instructions for printing here:

<https://base.brother.digital/manuals/graphics-lab/>

Please make sure that the resolution of your printfile is not too low. A resolution of 300 dpi in relation to the print format is recommended.

Develop your settings depending on the textile which is used.

With the **GTXpro Bulk** it is also possible to print **Direct-to-Film (DTF)**. If you want to print DTF you can find our **Reversal Guide** here:

<https://base.brother.digital/tip-sheets/general/reversal-guide/>

4 DURING DAILY WORK

4.1 THE PLATEN SENSORS

Normal situation:

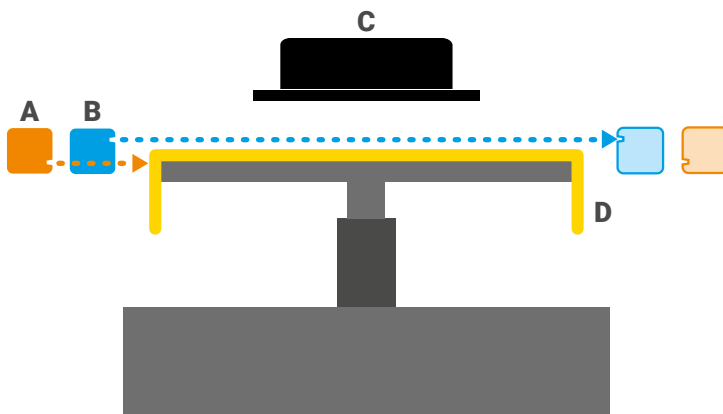

A: "Platen too low sensor"

It detects when the platen is too low and avoids generating ink mist and, as a consequence, bad quality prints.

B: "Obstacle sensor"

It is used to detect any obstacle for the printheads. The error occurs when obstruction is detected!

C: Printhead

D: Textile on platen

Platen too low error situation:

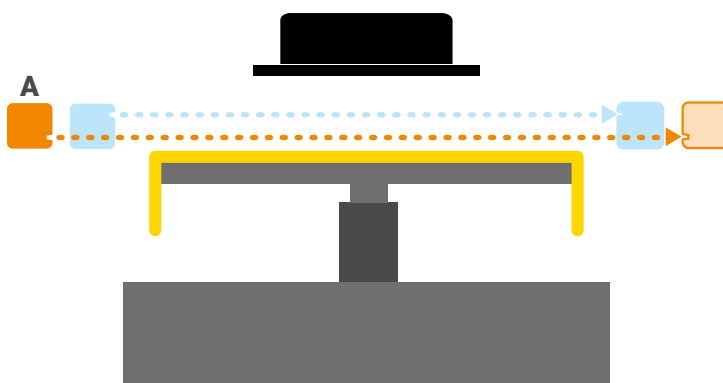

A: "Platen too low sensor" freely encounters the beam receiver on the other side of the platen. The sensor notes that the platen is too low and will stop the print. The error occurs when there is no obstacle on the platen.

Error 2072 appears on the display.



"Obstacle sensor" error situation:

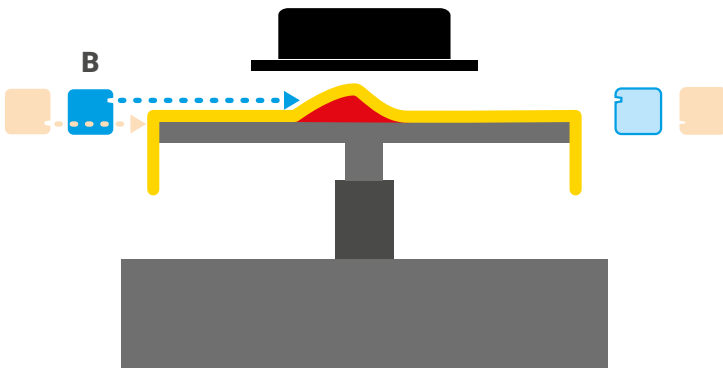

B: When the beam of the Obstacle sensor hits an obstacle, the printing process will be stopped immediately to avoid crashing the printheads.

Error 2070 appears on the display.

4.2 PRINT CURING ON GARMENT

Heat press settings for ink curing:

~ 180°C	~ 0.7-1.4 bar	for 35 sec
~ 360°F	~ 10-20 PSI	

The data are starting values for production.

Based on the results, self-optimised values could be used.

4.3 BEFORE REFILLING THE WHITE INK

In general the chemical composition of white ink includes pigments and other substances which are not soluble. This insolubility might lead to sedimentation in white ink what has to be eliminated by agitation before the refill process starts.

If the white ink is not agitated well before refilling, the print result will not be acceptable and the refill container as well as the white ink in the printer will be lost. In addition, the removal of the unusable white ink from the printer is time-consuming.

Before every refill of white ink you have to agitate the refill canister.



Tools that help to shake the white ink properly:

- A:** Fitness vibrating plate
- B:** Vibrational shaker
- C:** Gyrosopic mixer



Turn the canister upside down and check it with a flashlight. If there is only foam, but no sedimentation left, you can start the refill process.

The ink refilling process is guided by the menu. The IC-Stick, which is included with each ink canister, is necessary to activate the refill process in the menu.

- If the IC stick is not in place, the printer will ask for it.
- If the IC stick from a wrong color has been inserted, the printer will detect it and report it.
- If the IC stick is lost or broken, contact your dealer immediately.
- A reserve set of ink enables a continuous production.

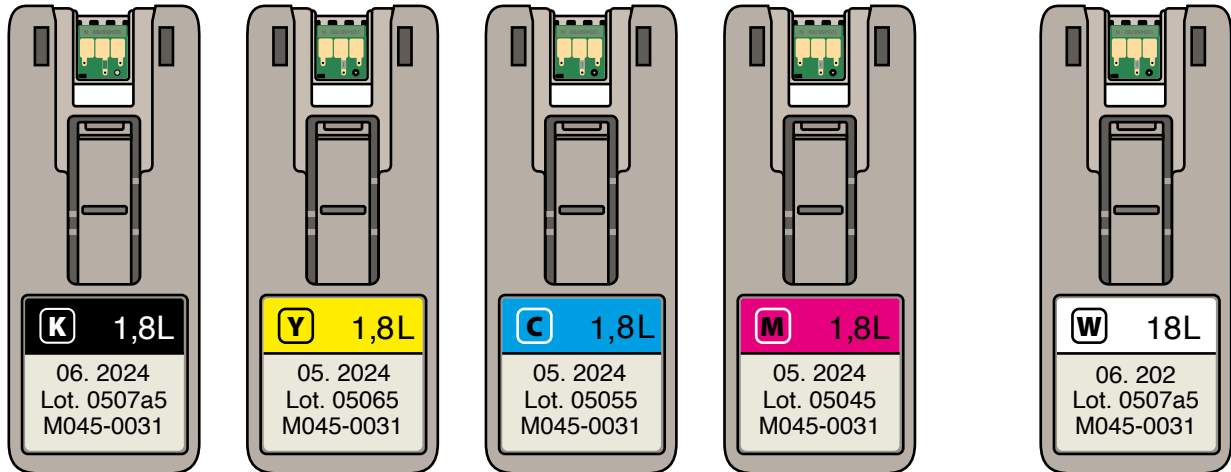

If the following message is shown on the display the mentioned color has to be refilled:

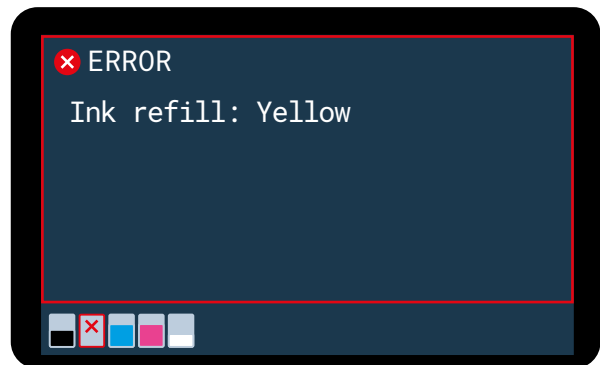

Choose "Ink refill" from the menu and follow the guided steps:

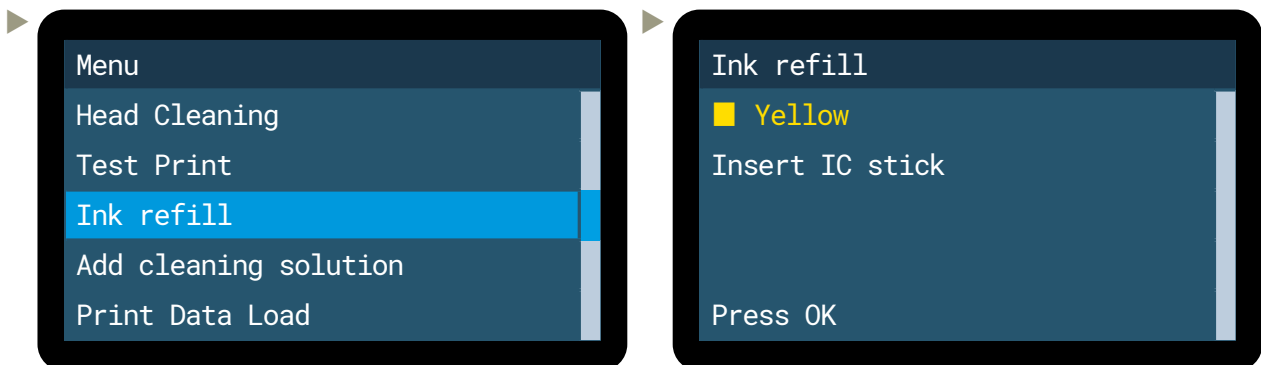

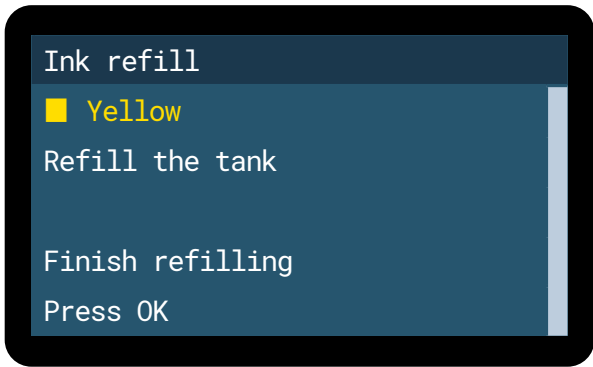
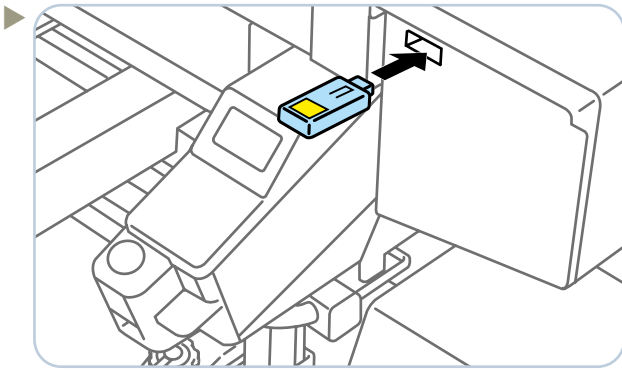

Insert the IC-Stick from the needed refill bottle into the dedicated slot of the printer.

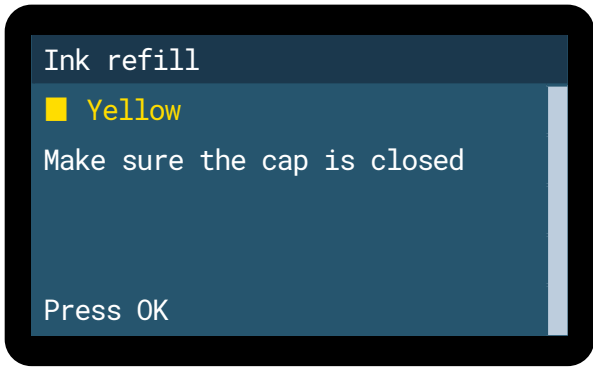
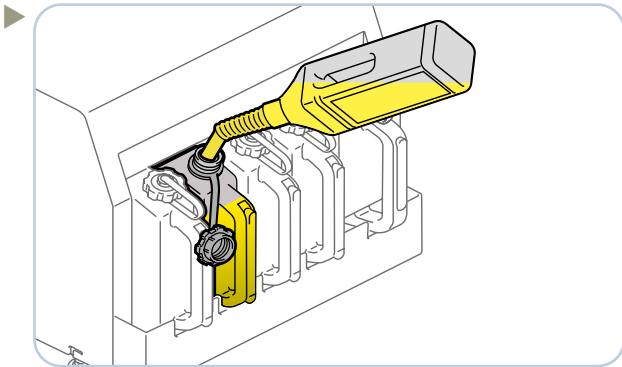

A rolling scissor lift is helpful for refilling white ink:



4.5 INK TANK CALIBRATION

Every 30 days a warning appears: the ink tank calibration must be performed for all ink tanks. If it is not performed after 32 days error, 1011 will occur.

You will not be able to print until calibration is done.

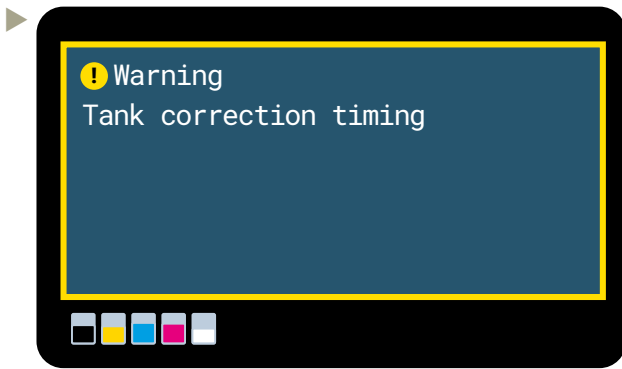

If this warning is displayed, ink tank calibration must be performed.

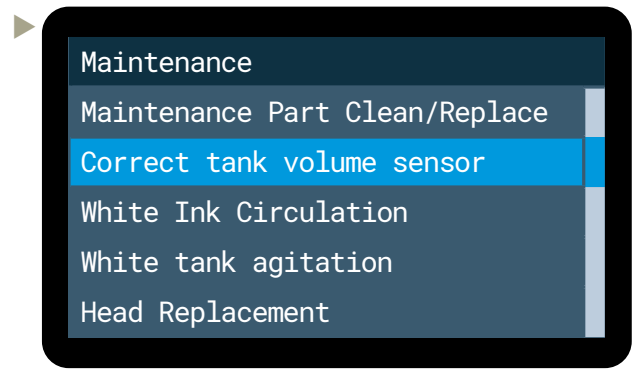

Select "**Correct tank volume sensor**"

- ▶ Check the ink level. If the ink level is on the border (like here), please select the higher number.

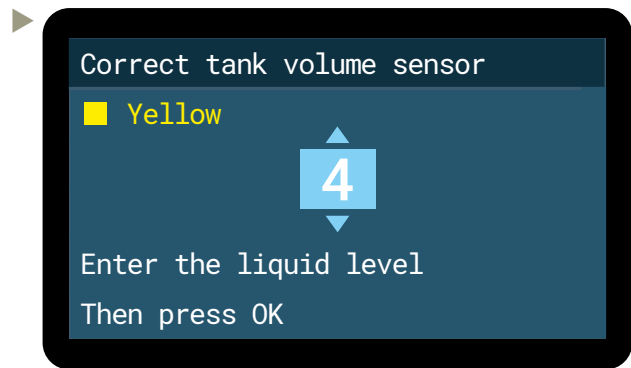
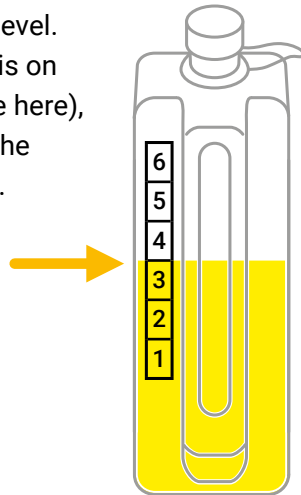

A flashlight is helpful to check the ink level of the white tank.

4.6 CLEANING SOLUTION REFILL

The refill of the Cleaning Solution circuit is done from the bottom tank. The upper tank is refilled by a pump activated by a sensor.

- ▶ Please refill the bottom tank, when "**C.S. Empty**" is shown on the display.



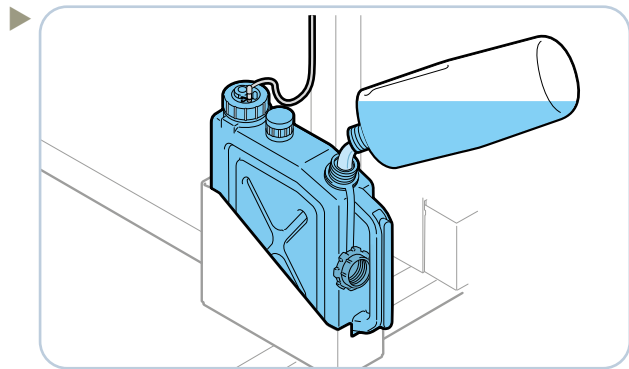
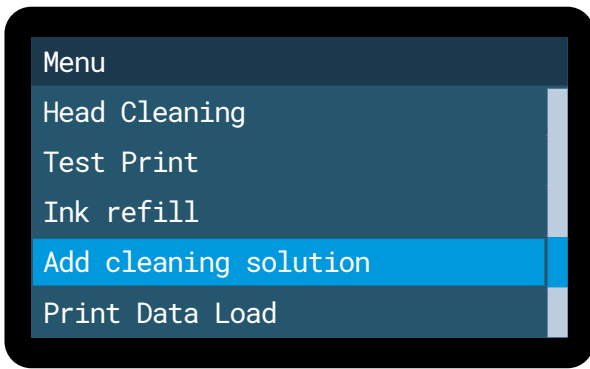

Select "**Filling solution tank**" and follow the instructions in the menu.

4.7 EVENT OF POWER FAILURE

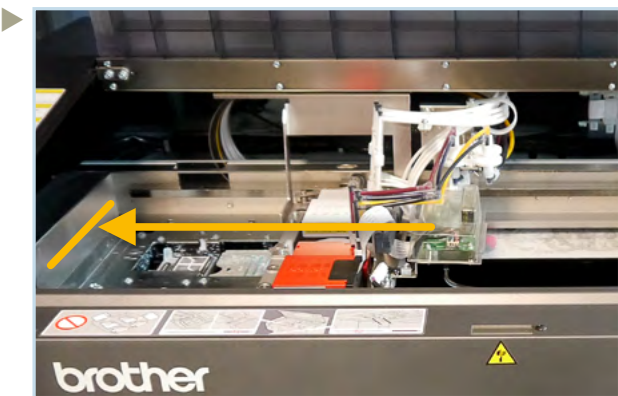

In the event of a power failure in your workshop, push the printhead carriage to the capping position by hand. This will protect the printheads from drying out for some minutes, giving you some time to solve the problem.

4.8 CLEANING AND REPLACING OF MAINTENANCE PARTS

In case of a "Warning/Error" message connected to a maintenance part, you always have to use the menu and run "Maintenance Part Clean/Replace".

In case of a "Warning/Error" message connected to the flushing foams, please carry out the following actions:

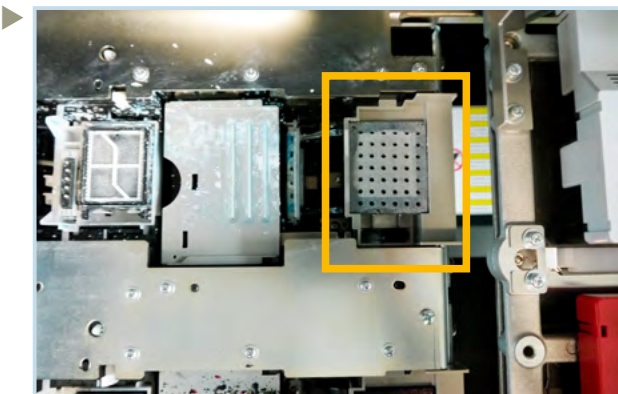

Position of the flushing foam (white side).

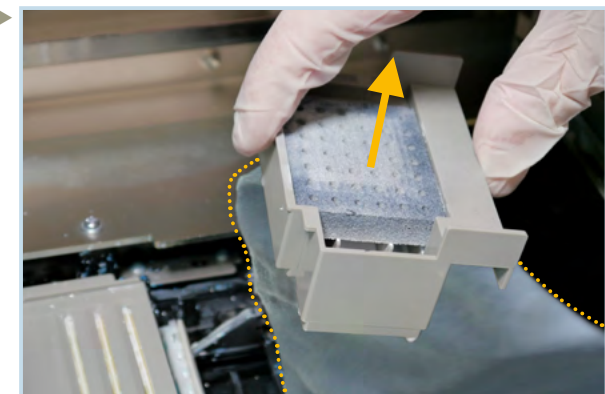

Lift up the flushing receiver and use a waste cloth to avoid that ink drips into the **GTXpro Bulk**. Remove the flushing foam and clean the receiver from inside to ensure that the hole in the receiver is open. Insert a new flushing foam and reinstall the receiver. Repeat the same on CMYK side.



In case of a "Warning/Error" message connected to the wiper cleaner, please carry out the following actions:

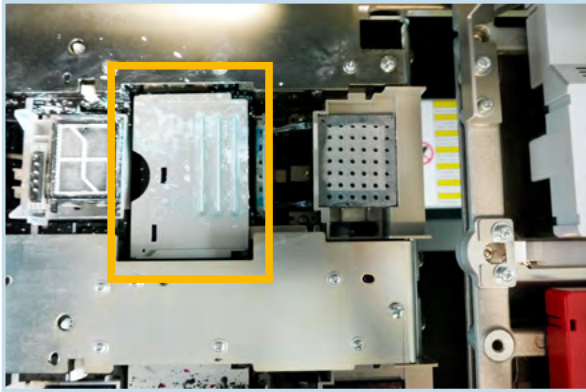

Position of the wiper cleaner (white side).

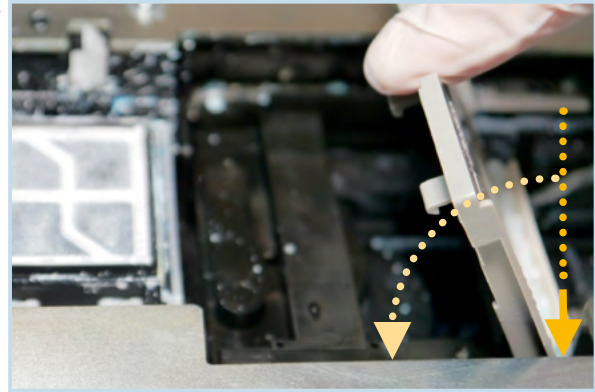

Lift the wiper cleaner up and remove it. When you insert the new one vertically, you hear a "Click" . Proceed in the same way on CMYK side.

In case of a "Warning/Error" message connected to the fan filter, please carry out the following actions:

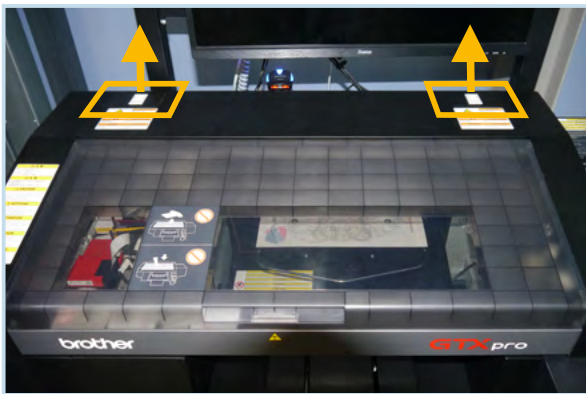

Position of the fan filters.
Please remove the two fan filter holders.

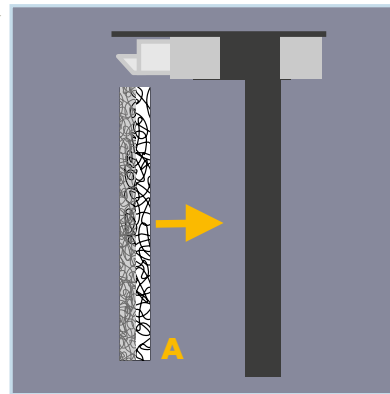

Insert a new filter with the coarse side **A** facing to the inner area of the **GTXpro Bulk** in each holder. Insert the holders in the **GTXpro Bulk**.



5 MAINTENANCES

5.1 WEEKLY MAINTENANCE

After the installation of your **GTXpro Bulk**, the following warning will appear every seven days:

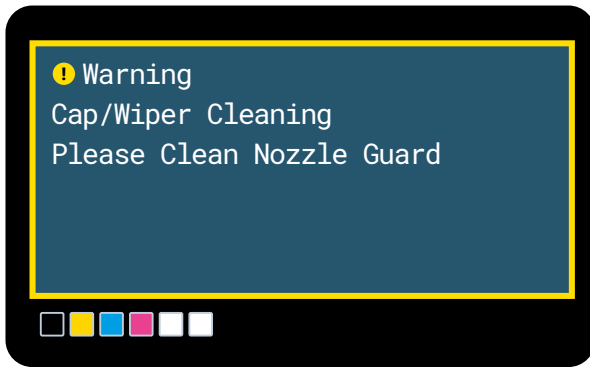

► Use the following menu to perform cleaning or "Maintenance Part Clean/Replace" after receiving the warning on the menu:

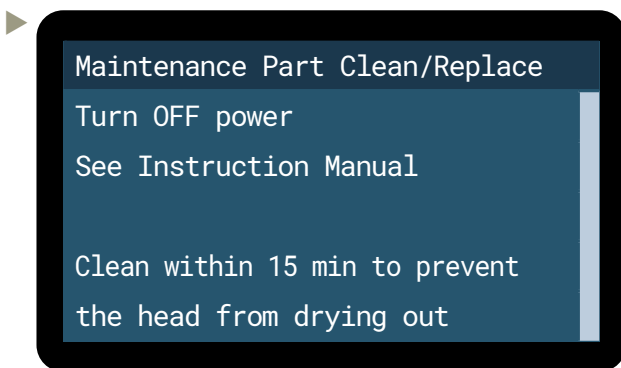
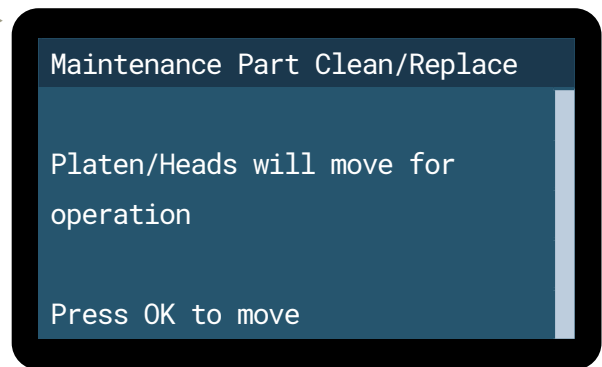
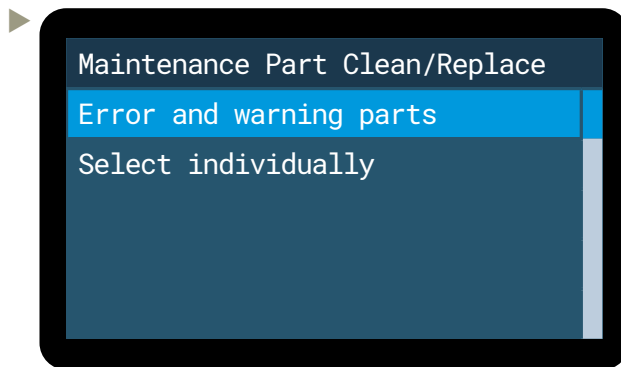
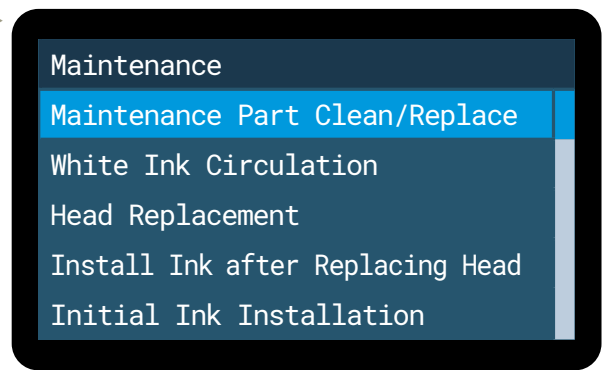
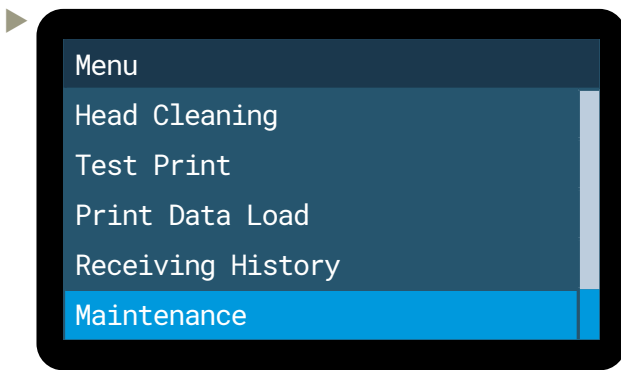

Perform the cleaning within 15 min to prevent the printheads from damage.



- For cap and exhaust cleaning you need cleaning sticks **T** and a bit of cleaning solution.



Make sure that you use new cleaning sticks.

Never use the same cleaning stick for white and color parts.

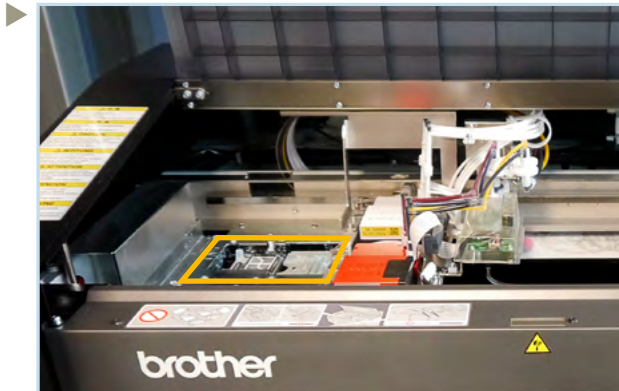

Position of the cappings, exhausts and wipers.

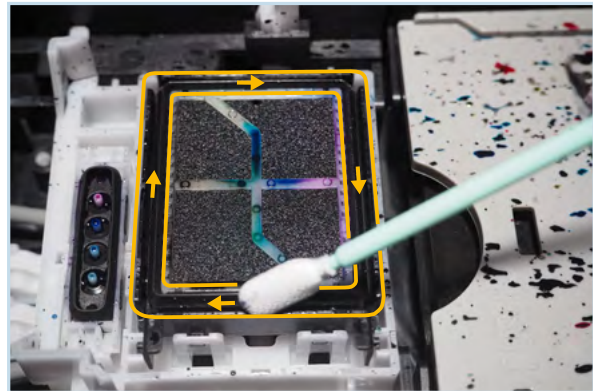

It is necessary to remove the ink residues remaining on the silicon lips of the caps. **Be careful not to touch the foam.**

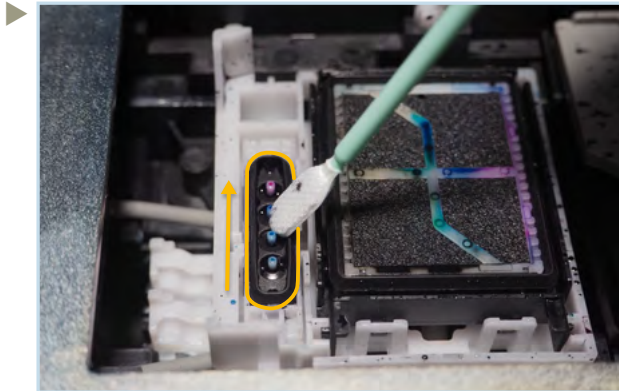

When cleaning the exhaust start from the front and go backwards. Always move the stick away from the drain hole placed in front.

Before you start cleaning the white capping, take a new cleaning stick T and fresh cleaning solution. Pour the used cleaning solution into the waste tank.

- **Before you clean the wipers take a new cleaning stick T and fresh cleaning solution.**

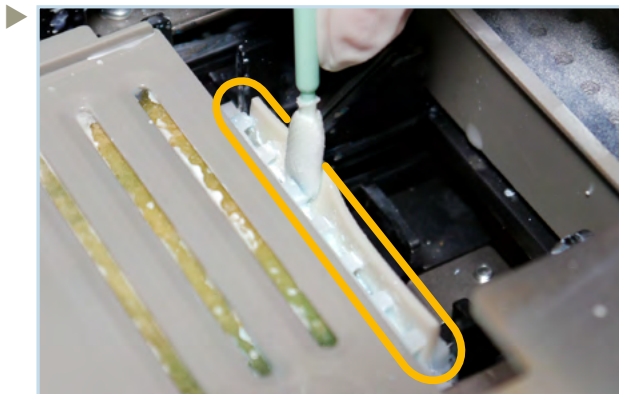

Clean the wiper on both sides, under the teeth of the wiper holder and remove the dried ink.

Before you clean the color wiper take a new cleaning stick T and fresh cleaning solution. Pour the used cleaning solution into the waste tank.

- Use a new cleaning stick **R** and fresh cleaning solution for the cleaning of the nozzle guards of each printhead.



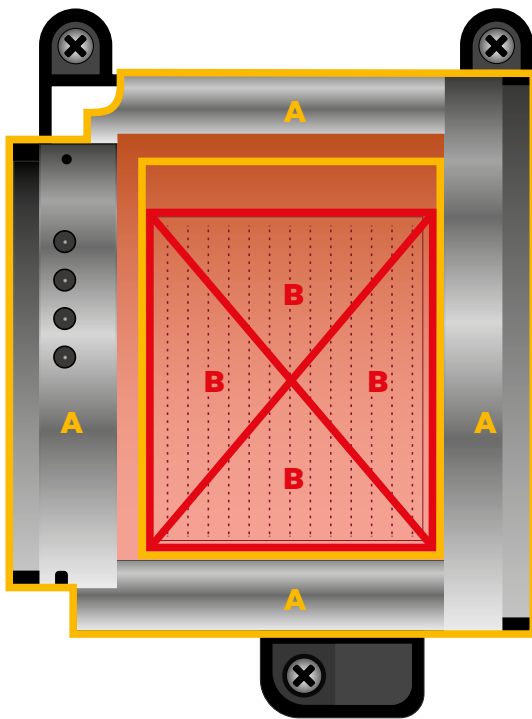

View from below

A: Surfaces to be cleaned on the underside of the printheads.

B: Do not touch the nozzle surface at all.



Side view

► Remove the platen to have more space for the cleaning.

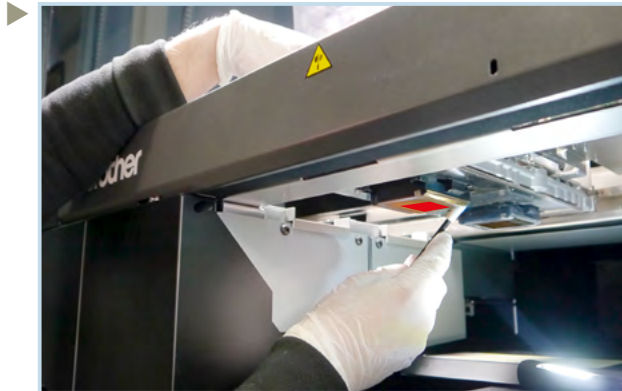

Fix the printhead carriage by hand during the cleaning.

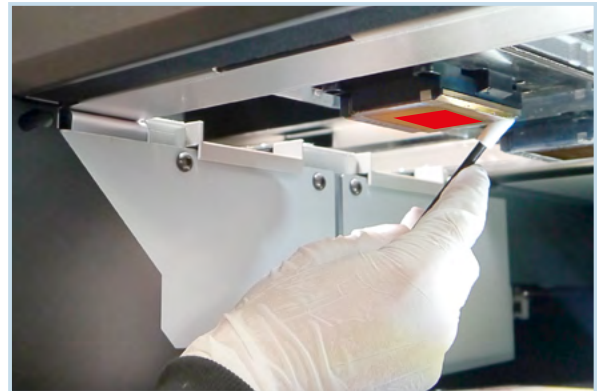

Be sure not to touch the nozzle surface.



5.2 MONTHLY MAINTENANCE

Due to the production process, lint and ink mist contaminate the inside of the machine. These must be removed to increase the longevity of the machine.

Use the menu "Maintenance Part Clean/Replace".

Perform the cleaning within 15 min to prevent the printheads from damage.

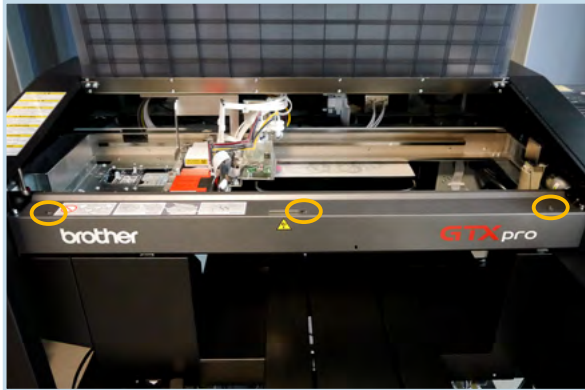

Remove the 3 screws to remove the encoder cover.

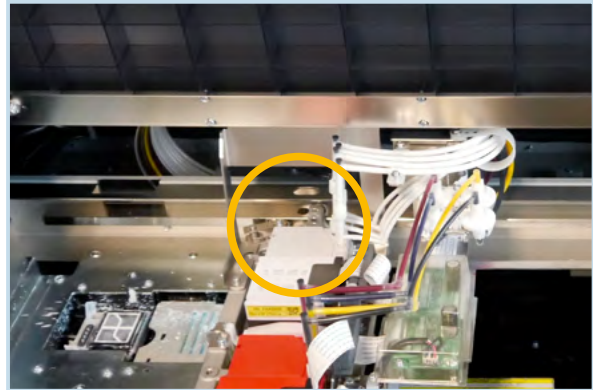

Position of the 4 carriage rollers behind the white printhead.

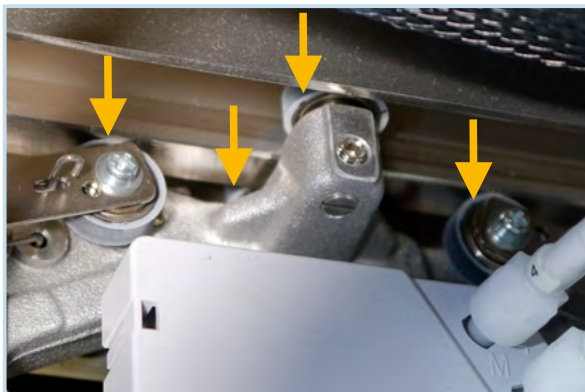

Clean the 3 carriage rollers on top and the roller underside with a new stick **R** dipped in cleaning solution.

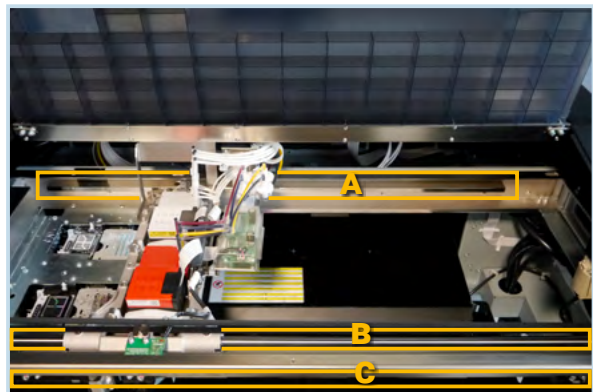

Use a non-fuzzy cloth moistened with a bit of Isopropyl Alcohol (95%) for the cleaning of:

A: The 3 sides of the roller guide

B: The carriage guide shaft

C: Both sides of the encoder strip.

Then apply a proper amount of *Molykote 30 Grease* onto the carriage guide shaft only.

Do not use Isopropyl Alcohol on any other parts.

Perform a CR Speed Adjustment via the menu:

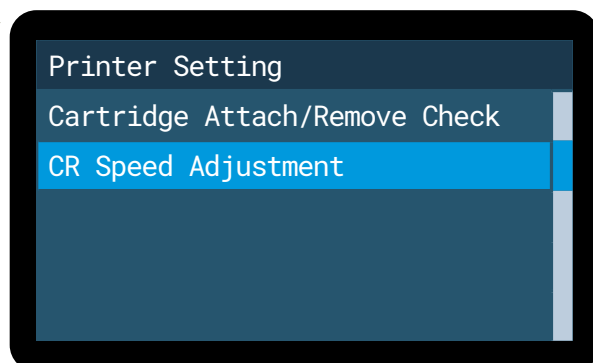
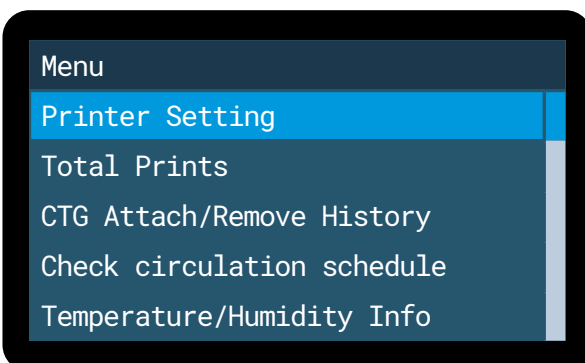

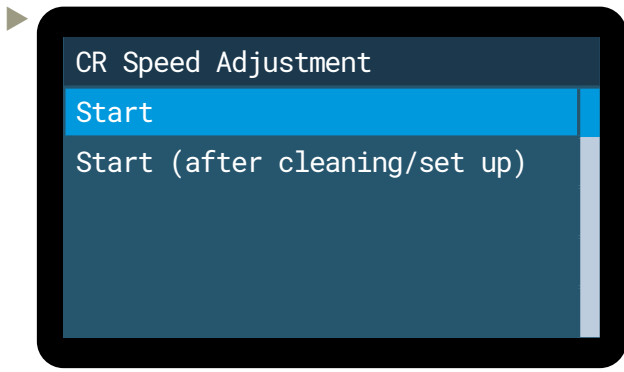

▶ Follow and wait till finished.

▶ Print out a nozzle check pattern and do a nozzle cleaning if necessary.

5.3 PREVENTIVE MAINTENANCE

Preventive maintenance of the machine is necessary to keep the machine in good working condition and to ensure good printing quality.

The following maintenance intervals must be observed: at **25k / 50k / 75k / 100k** prints and so on.

Regular maintenances are carried out by the service technician.

5.4 EXTRACT A LOGFILE FOR SUPPORT

If you need technical support, the technician can ask you for a log file of the printer, which is necessary to solve the problem.

Insert a USB stick in the front slot of the **GTXpro Bulk** to be able to copy the logfile. Then use the menu:

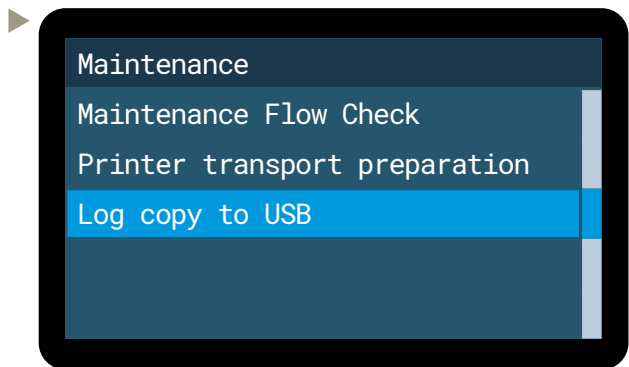
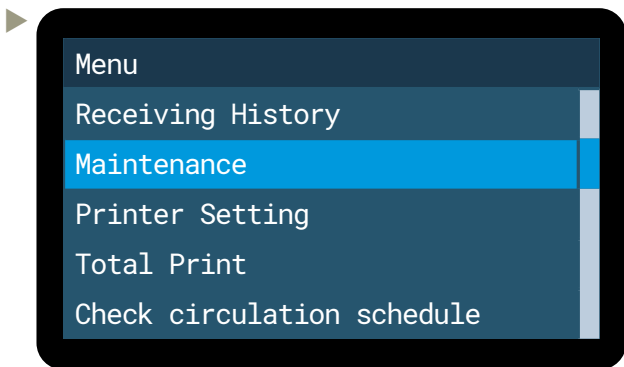

It is also possible to create a logfile with the < *Maintenance Tool* > from your PC:

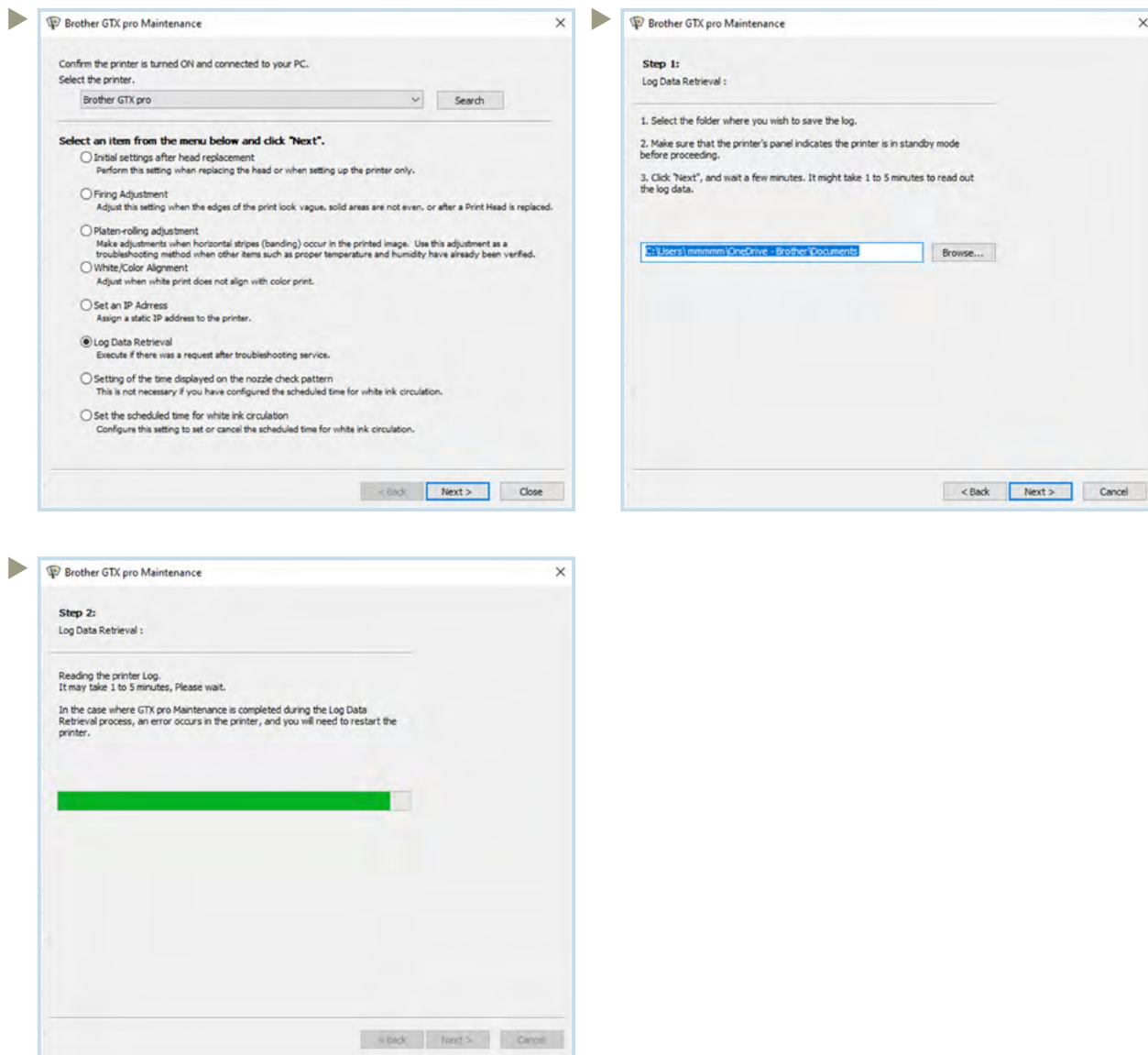

5.5 WHEN NOT USING THE PRINTER FOR A LONG PERIOD OF TIME

If the **GTXpro Bulk** is not going to be used for a prolonged period of time contact your local dealer, because preparatory operations for storage must be carried out.

If you want to resume production after several hours or days, the following preparatory steps are necessary:

- ▶ Empty the waste ink tank;
- ▶ Check the amount of cleaning solution in the cleaning solution tank and refill the tank if its amount is below the proper level
- ▶ Print out a nozzle check pattern for white and CMYK.
If a non-firing nozzle is found, perform *“Head Cleaning”* and then another test print.
Continue the same process until all nozzles are open again.



6 ORDER LISTS

Inks

Name	Quantity	Order Number
C CYAN Refill ink bottle (1.8 L)	1	BGCX40C002K0152
M MAGENTA Refill ink bottle (1.8 L)	1	BGCX40M002K0152
Y YELLOW Refill ink bottle (1.8 L)	1	BGCX40Y002K0152
K BLACK Refill ink bottle (1.8 L)	1	BGCX40K002K0152
C CYAN Refill ink bottle (9 L)	1	BGCX40C009L0132
M MAGENTA Refill ink bottle (9 L)	1	BGCX40M009L0132
Y YELLOW Refill ink bottle (9 L)	1	BGCX40Y009L0132
K BLACK Refill ink bottle (9 L)	1	BGCX40K009L0132
W WHITE Refill ink bottle (18 L)	1	BGCX40W020K0032

Liquids

Name	Quantity	Order Number
CS CLEANING SOLUTION (1.8 L)	1	BGCX40E002K052
CS CLEANING SOLUTION (5 L)	1	BGCX40E005K042
PT PRETREATMENT (5 kg)	1	BGCX40P005K0042
PT PRETREATMENT (20 kg)	1	BGCX40P020K0032
PT PRETREATMENT (200 kg)	1	BGCX40P02HK032
PT VIVID BRIGHT 3.0 (4 L)	1	N40001910
PT VIVID BRIGHT 3.0 (10 L)	1	N40002470
PT POLYESTER PRETREATMENT (2 L)	1	N40000224

Other parts

Name (Pieces)	Quantity	Order Number
Flushing Foam (2)	1	SC0935001
Wiper Cleaner (2)	1	SB6673101
Fan Filter (2)	1	SB7007001
Cleaning Stick R (50)	1	SB7008001
Cleaning Stick T (100)	1	N40001601
Cleaning Cup (1)	1	SB6925001

DTF Sheets

Name (Pieces)	Quantity	Order Number
Schulze DTF Sheet A3 (100)	1	N40002302
Schulze DTF Sheet 40x50 cm (100)	1	N40002303
ITEX DTF Sheet A3 (250)	1	N40002094
ITEX DTF Sheet 32x45 cm (500)	1	N40002374

DTF Powder

Name	Quantity	Order Number
Schulze DTF Powder (1.5 kg)	1	N40002096
Schulze DTF Powder (5 kg)	1	N40002095
Schulze DTF Powder (20 kg)	1	N40002094
ITEX DTF Powder (2 kg)	1	N40002374
ITEX DTF Powder (20 kg)	1	N40002373

Platen

Name	Quantity	Order Number
Baby Platen 7x8 in (17,8x20,3 cm)	1	N40001219
Youth Platen 10x12 in (24,4x30,5 cm)	1	N40001220
Adult Platen 14x16 in (35,6x40,6 cm)	1	N40001790
Large Platen 16x18 in (40,6x45,7 cm)	1	N40001222
Oversize Platen 16x21 in (40,6x53,3 cm)	1	N40001275
DTF Platen 14x16 in (35,6x40,6 cm)	1	N40002514

Contact your responsible dealer if you are interested in any kind of custom platen.





Brother BASE - Your download area

If Firmware Updates, Graphics Lab or Cookbooks, at **Brother BASE** you can find all the knowledge and tools you need for a convenient experience with your industrial printer from **Brother**. You will also find driver, apps, third-party manuals, TIP-Sheets, certificates and more.

<https://base.brother.digital>

myze

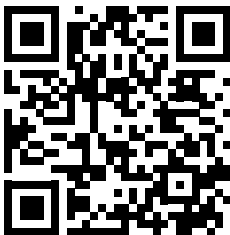

Myze - On demand made easy

Sell more and produce more efficiently with the cloud platform for the on-demand market. Developed by Brother EMEA.

Do you want to produce more efficiently? Would you like to be able to create your own products quickly and always have an overview of all key figures? Then **Myze** is the solution. **Myze** supports **Brother** direct to garment printers with DTG and DTF, Embroidery and mug sublimation printing. **Myze** is the platform for Production Workflow, the connector to Online shops, Market-places and Analytics.

<https://myze.brother.digital>

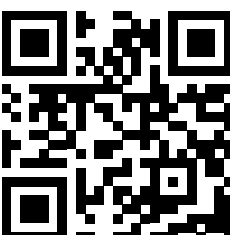

Publisher of this document:
Brother Internationale Industriemaschinen GmbH
Düsseldorfer Straße 7-9
46446 Emmerich am Rhein
Germany

www.brother-ism.com

