

VASTEX

SCREEN PRINTING EQUIPMENT

Exposing Units

Assembly and Operation Instructions



E1-2124



E4731



E2331

This manual contains the following information:

- Introduction, Machine Specifications
- Safety Information
- Assembly Instructions
- Operating Instructions
- Troubleshooting
- Emulsion Tips
- Wiring Diagrams
- Vacuum Pump Manual
- 01-00-005 Warranty
- 01-00-006 Warranty Summary
- 01-00-015 Terms and Conditions

Vastex International, Inc.
1032 N. Irving St.
Allentown, Pa. 18109 USA
Phone# 610 434-6004
Fax# 610 434-6607
Web Site www.vastex.com
E-Mail info@vastex.com

Vastex Exposing Units

(Ultraviolet Exposure Systems)

Introduction:

Thank you for purchasing your printing equipment from Vastex International Inc.

Vastex has been designing and building printing equipment since 1960. We have the knowledge and experience, and are supplying the printing industry with quality equipment at an affordable price. You can be confident your purchase will give you years of trouble free service.

Specifications & Part Numbers

	E1-2124	E2331	E4731
Overall Size (lid closed) Depth x Width x Height	36"x32"x14" (91.4 x 81.3 x 35.6 cm)	42" x 36" x 48" (106.7 x 91.4 x 121.9 cm)	42" x 52" x 45" (106.7 x 132.1 x 114.3cm)
Weight	100 lbs (45.6kg)	180 lbs (81.6kg)	273 lbs (123.8kg)
Screen Capacity	21"x24"	23" x 31"	(2) 23" x 31" or a 31" x 47"
Power Requirements	120v: 60Hz@ 2.5 Amps 240v: 50/60Hz, 1.25 Amps	120v: 60Hz @ 3.5 Amps 240v: 50/60Hz @ 2 Amps	120v: 60Hz @ 6.6 Amps 240v: 50/60Hz @ 4 Amps
Exposure Timer	Analog Timer (P/N: 04-01-085)	Digital Timer (120V P/N: 04-01-083) (240V P/N: 04-01-084)	Digital Timer (120V P/N: 04-01-083) (240V P/N: 04-01-084)
Vacuum Hold Down	Single 1/16 Hp Pump (120V P/N: 04-02-040) (240V P/N: 04-02-041)	Single 1/16 Hp Pump (120V P/N: 04-02-040) (240V P/N: 04-02-041)	Dual 1/16 Hp Pumps (120V P/N: 04-02-040) (240V P/N: 04-02-041)
Glass Reorder Numbers	(P/N: 04-08-044)	(P/N: 04-08-048)	(P/N: 04-08-049)
Light Source	(4) 24" Black UV Bulbs (P/N: 04-08-006)	(6) 28" Black HO UV Bulbs (P/N: 04-08-050)	(12) 28" Black HO UV Bulbs (P/N: 04-08-050)
Vacuum Blanket P/N	(P/N: EUB-2124)	(P/N: EUB-2331)	(P/N: EUB-4731)
Lid Seal P/N	(P/N: 04-05-174)	(P/N: 04-05-174)	(P/N: 04-05-174)
Floor Model/Tabletop	Table Top Only	Standard: Floor Model Optional: Tabletop	Floor Model Only
Warranty	1 Year; Manufacturer defects	3 Years; Manufacturer defects	3 Years; Manufacturer defects

Safety Information

Read this manual before assembling and operating your exposing unit.

Safety:

- The operator should read and understand this manual before operating this equipment. Store manual and safety information near equipment for easy access to operators.
- Never leave equipment unattended while in operation.
- Children and pets must be kept clear of the work area.
- Do not store any objects on top of the exposing unit.
- Unplug power cord before removing glass or entering control box.
- Do not operate if any guard or cover has been removed.
- Do not operate if power cord is damaged.

** WARNING HANDLE GLASS WITH CARE **

- Wear gloves when handling the glass
- Lay glass only on a flat protected surface
- Tempered glass, although strong, can shatter if the edges are subject to an impact

Tools Required: Medium Phillips Head Screw Driver, 7/16", 9/16", 1/2", and 5/8" Wrenches

General Information:

- Exposing Unit must be on a flat surface to eliminate stress on the glass.
- **Caution!** Screens must be free of sharp edges. All surfaces coming in contact with vacuum blanket should be rounded and smooth.
- If installing onto the Vastex utility cart, see the utility cart manual for attachment procedure. (*E-1000 Only*)
- Black UV light bulbs are used in Vastex exposing units. Ultraviolet output of bulbs will lessen over time. Replacing of bulbs is recommended if longer exposure times are noticed. Changing bulbs every 1 to 2 years is recommended
- Keep the lid in the raised position when not in use. It will increase the life of lifting cylinders and the rubber blanket.

Vastex E-mail assistance

Purchasing & Product Info:

sales@vastex.com

Electrical Support:

stech@vastex.com

Tech Support, Mechanical Setup, and Operation

techsupport@vastex.com

Screen Printing Issues & Support:

printech@vastex.com

Assembly Instructions

Getting started:

Your Exposing Unit has been fully assembled and tested in our factory. The bulbs have been removed and packaged separately. The bulbs and packing material are inside of the exposing unit cabinet. Both lid lifting cylinders have been removed from their upper mounting stud and secured to the side of the cabinet.

Be careful not to damage the rubber vacuum blanket when removing the Exposing Unit from its crating. It is best to keep the lid locked closed when lifting the exposing unit. Carefully remove the unit from its crate and place it on a suitable surface. It is important that the surface be flat, an uneven surface can put stress on the glass causing it to crack.

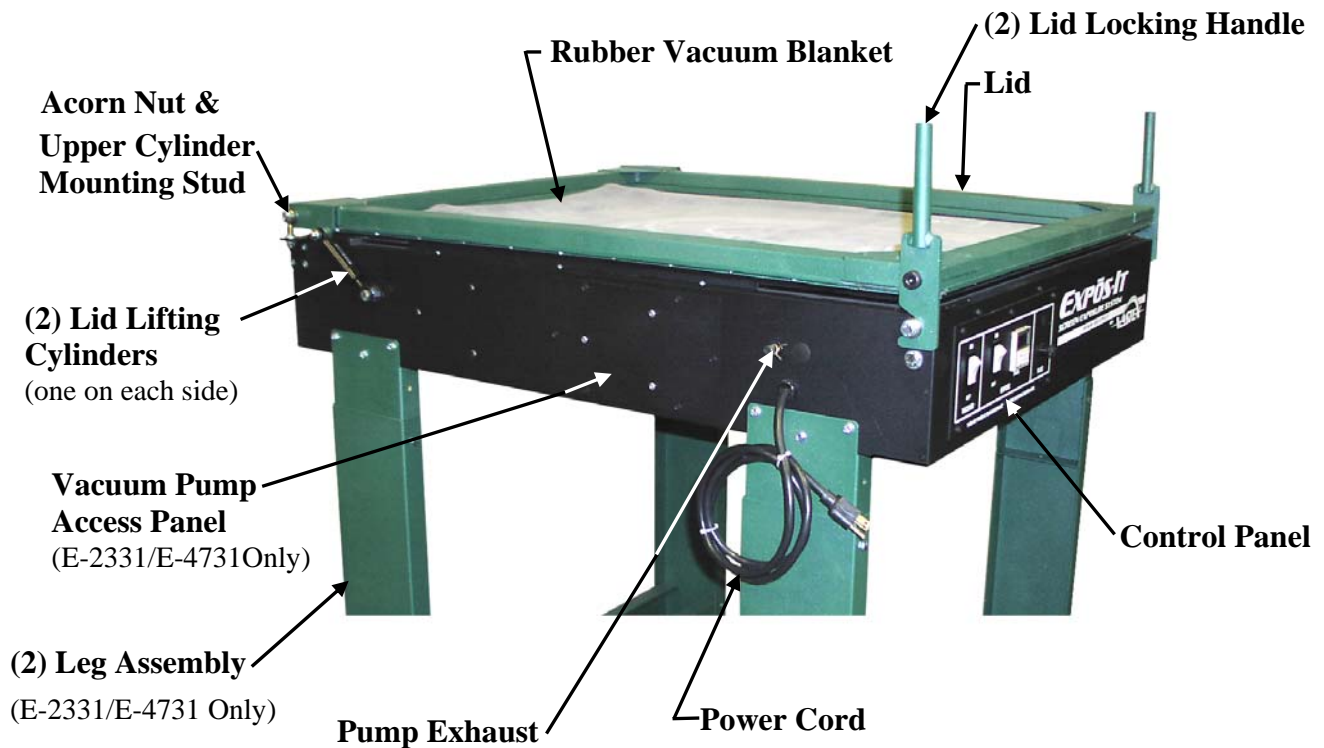

1.) Install Legs on Exposing Unit (Models E2331/E4731 only)

1a) Place Legs on a clear spot on the floor, 28.5" (72.5cm) apart as shown in picture 1a.

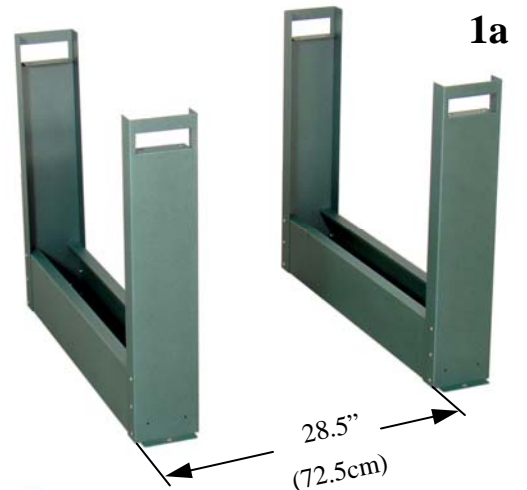

1b) Lock lid handles as shown. Carefully lower the exposing unit down onto the legs. Two people are required to do this as caution must be taken to not damage the machine's glass or rubber blanket.



1c) Legs are installed with (8) 3/8" bolts, (16) 3/8" washers and (8) 3/8" nuts. Use (2) 9/16" open end wrenches and tighten all bolts well.



2.) Install Lid Lifting Cylinders

Remove the acorn nut from the upper cylinder mounting studs located on both sides of the lid. Unlock and carefully lift lid far enough to slide lifting cylinders onto studs. Replace acorn nuts onto stud. **Snug only** with a 5/8" wrench. Do not over tighten!

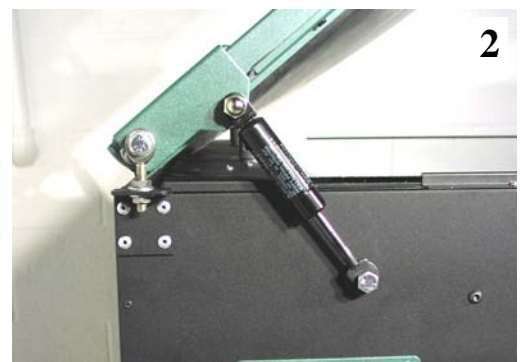

3.) Glass Removal

There are three glass retainers. One at the front and one on each side. The side glass retainers have been adjusted at the factory. The side retainers guide the glass squarely against the back seal when reinstalling the glass. Do not remove side retainers. Remove the front retainer. Slide the glass towards the front to remove. Carefully set glass on a flat, protected surface.

Wear gloves when handling the glass. Glass is tempered and although strong, can shatter if the edges are subjected to an impact.

4.) Unpack the light bulbs and packing material. Remove bulbs from their protective wrapping. It is important to keep the inside of the cabinet clean. Before installing the bulbs, it is a good idea to vacuum out any loose debris from inside the cabinet.

5.) Bulb Installation

Be sure your hands are clean or clean gloves are used. Install the bulbs by inserting the pins on the end of the bulbs into their holders mounted on the light tray. Rotate bulb 90 degrees until it clicks in place. Test the bulbs before installing the glass. Plug in the power cord and turn on the switch marked "EXPOSE". All lights should now be on. If any light is not working, check that the pins are not bent and are correctly seated into the bulb holders. See the trouble shooting section if bulbs still do not light.

6.) Reinstalling the glass.

Before installing the glass, switch the vacuum pump on and off to verify it is functioning properly. Clean both sides of the glass with glass cleaner and a lint free rag. Vacuum inside of cabinet. Position the glass seal side down, blue tape towards the front, on the front edge of the cabinet, and between the side retainers. Slide glass back until it contacts the back seal. **It is important that the glass is seated squarely against the back seal.** Install the front glass retainer, do not fully tighten retainer screws. Pushing back on both sides of the front retainer, tighten the three screws. **Do not over tighten!**

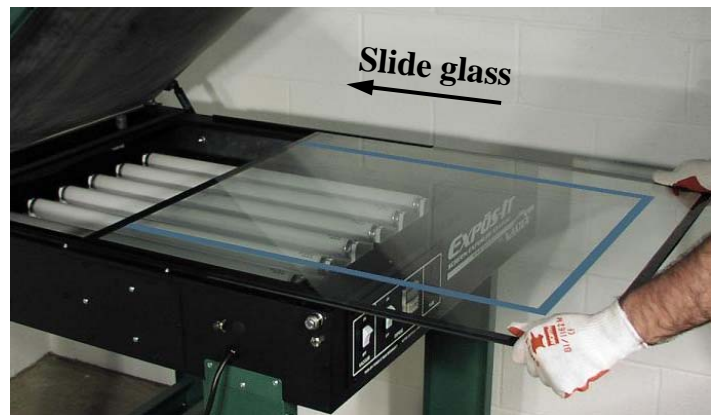

Note:
The glass must be tight against the back glass seal in order to make a good vacuum.



7.) Screen Stops

E-1000 Two or three screen stops are installed at the factory. Two Rear stops and one (Optional) Side stop.

E2331/E4731 Rear stops are installed at the factory. The side stop assembly is an option with the machine and is only necessary when using a Vastex VRS system with 20" or 21" wide screens.

To install the optional side stop assembly on your machine, remove the three screws near the back screen stop. Install the side stop assembly.

Do not over tighten screws.

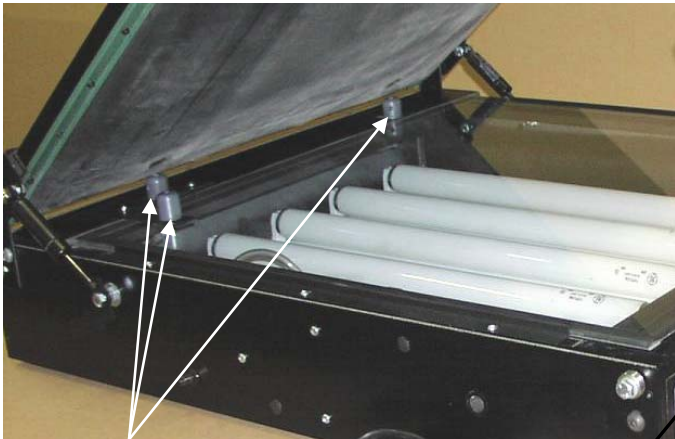

E-1000 Back/ (optional) Side Stops



E2331



E4731

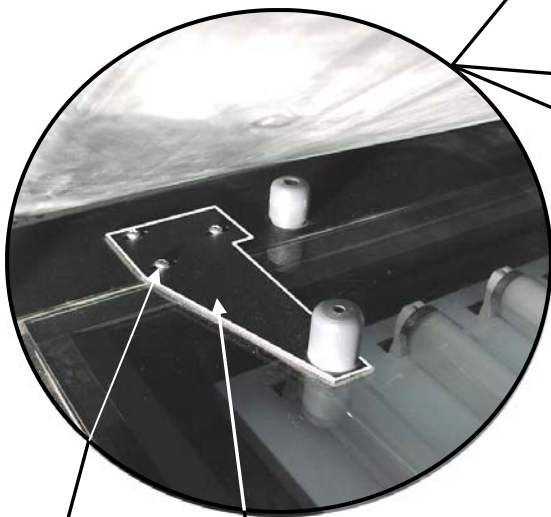

(Optional) Side Stop Bracket

Side Stop Assembly Position bracket to the left in it's mounting slots for a 21" wide screen. Position it to the right for a 20" wide screen.

Operating Instructions

Overview:

Your Exposing Unit is equipped with Black UV bulbs, exposure timer, vacuum pump, and separate switches for pump and lights.

The vacuum pump draws the air out from between the blanket and glass. This flattens the coated screen and positive to the glass making for a sharper exposed image.

1.) Raise the exposing unit lid and wipe the glass surface clean with a lint free rag.

2.) Position the screen with positive attached onto the glass and against screen stops. If the side stops are installed the screen should be positioned against them as well.

E-1000: Position the screen against the screen stops and centered left to right.

E2331/E4731: Do not position any screen outside of the indicated max screen area on the glass. Damage to vacuum blanket can result if screens are placed outside this area.

3.) Lay the small string attached to the rear of the exposing unit over the edge of the screen. This will assist in achieving a good vacuum in the center of the screen.

4.) Lower the lid and lock closed with both handles.

5.) Turn on the vacuum pump switch. The rubber blanket will slowly be drawn down around the screen. The pump must remain on throughout entire exposing time.

6.) Set Exposure Time

E-1000 Exposing Units use an analog timer, rotate knob to set time.

E2331 and E4731 units use a digital timer, push buttons to set time.

(Note: An exposure calculator is recommended to determine correct exposure time)



Analog Timer
(E-1000 Only)

Timer is set at the factory to minutes. Adjust the timer by turning the dial to the desired amount of minutes. Timer can be set from 0-30 minutes with this setting. Refer to timer spec sheet to change units of time measured.



Digital Timer

Timer is set at the factory to minutes. Adjust the timer using the six buttons on the left. The letter on the right corresponds to the units of time being measured. A lower case m means the timer can be set between 0-999 minutes.

7.) Turn on the expose switch. The timer will start the lights and run for the preset time. After the time has expired, the lights and vacuum pump will automatically shut off. Your screen is now exposed.

8.) Turn the PUMP switch off first then the EXPOSE switch.

9.) Unlock lid to break the vacuum and proceed to your washout booth to finish screen wash down.

Troubleshooting

Loss of Vacuum: This can be caused by several problems. Check the following items in order listed.

- 1.) Verify that vacuum pump is running.
- 2.) Examine the rubber blanket for holes or cuts.
- 3.) Check that the holes in the back screen stops are not blocked. Turn on the pump and verify that there is vacuum through the stops.
- 4.) Check that the clear tube protruding through left side of cabinet wall is unobstructed. This is the vacuum pump exhaust.
- 5.) Verify that the back glass seal is not damaged. Loosen the front glass retainer plate. Reseat the glass squarely against the back seal and retighten the front retainer.
- 6.) There is a foam seal around the perimeter of the lid between the rubber blanket and lid frame. With the lid locked down, check that the lid seal and blanket is contacting the glass at all four sides. If this seal is not contacting the glass it will be necessary to adjust the lid lower.
Proceed as follows. (Pictures below for reference)

Remove both Lid Lifting Cylinders from their upper mounting stud. Carefully lower the lid.

Rear Lid Adjustment

E-1000: Using a 7/16 wrench, loosen (4) bolts at

each back corner. Push down on lid to slightly compress seal and retighten bolts.

E2331/E4731: Using a 1/2" wrench, loosen the top nut 1/2 turn then tighten the bottom nut 1/2 turn. This will adjust the lid down .025". Do this to both sides until vacuum seal is achieved

Front Lid Adjustment

All Expositis: Using a 9/16 wrench, loosen (2) bolts at each front corner about 1/8 of a turn. Tap on the top bolt head slightly to move the bearing down. Be careful to avoid moving it too much. For reference, measure from the top of the bearing to the bottom of the lid when closed, do not adjust more than 1/16 of an inch.

7.) Contact Vastex for technical support if these steps fail to resolve the problem.

Light Troubleshooting:

1.) If a bulb fails to light, it will be necessary to remove the glass to get to the bulbs. Remove the faulty bulb and switch it to another location on the light tray. If the bulb still does not light the bulb is must be replaced. If the bulb does light there is a wiring problem. Contact Vastex for technical support.

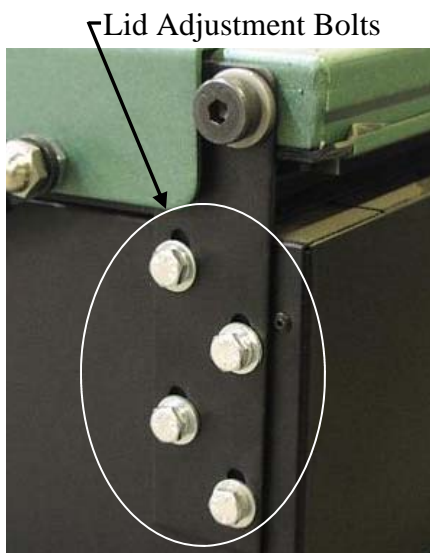

E-1000
Rear Lid Adjustment

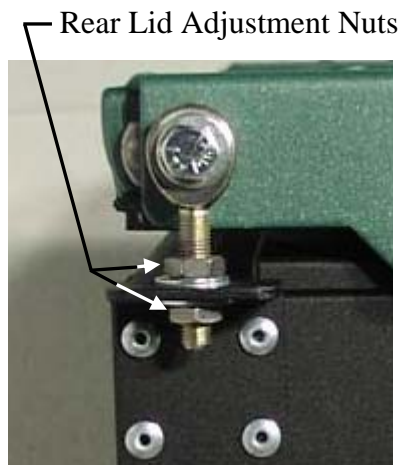

E2331/E4731
Rear Lid Adjustment

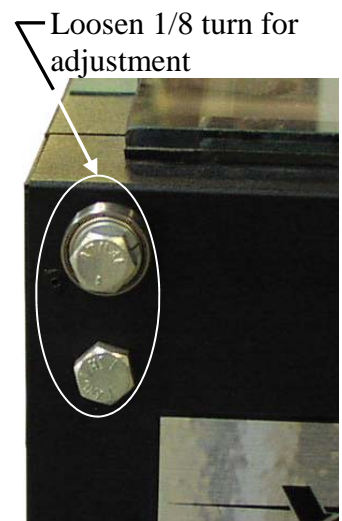

All Expositis

Emulsion information for the screen printer

A technical information article by Douglas Grigar

Screen printers have available six types of photoreactive stencil materials. There are three direct emulsion choices, diazo, diazo/photopolymer (dual cure), and SBQ-photopolymer. There are also three photo reactive film choices, indirect film, direct/indirect film, and photoreactive capillary films.

Diazo emulsions are the least expensive and the first of the three emulsion types available on the market. Diazo emulsions are mid range in available exposure latitude and can have good edge definition. Drawbacks are that many require hardeners for long runs or water resistance lower solids content is often needed for reasonable viscosity.

Diazo Photopolymer emulsions are hybrids of the diazo and photopolymers and are also called dual cure. Dual cure emulsions are the newest available emulsions. Due to the hybrid nature they have the largest available feature and quality range. Dual cure emulsions will have the largest exposure latitude and are available in various levels of water and solvent resistant features. Dual cure emulsions generally have the best resolution, definition, and bridging qualities. Dual cure emulsions are midrange in price, and higher solids content versions are available with reasonable viscosity.

SBQ- Photopolymer emulsions are very fast in their exposure speeds but also have the smallest exposure latitude. They are pre mixed and have the longest shelf life. Pure photopolymer emulsions are the most expensive and are best matched with high quality single point exposure systems. Pure photopolymer emulsions have good resolution, definition, and bridging qualities. Pure photopolymer emulsions have the highest solids content available with reasonable and often excellent viscosity.

The solids content in an emulsion does

example would be that pure photopolymer emulsions are available in very high solids content with low viscosity. Emulsion viscosity can also change with temperature. Lower temperatures cause the emulsions to thicken. Solids content less than 30% with low viscosity are often difficult to coat without a mess. In addition, lower solids percentage will require multiple coatings to achieve reasonable mesh coverage.



Fig. 1

Emulsion Over Mesh or EOM is a measurement of the emulsion thickness on the face or substrate side of the mesh. EOM is a percentage of the mesh thickness. (Fig. 1) Too low of an EOM ratio will prevent a good gasket seal, prevent good detail resolution, and increase chances of saw tooth edges. Manufacturers recommend an EOM ratio of 10 to 20 percent.

With an emulsion stencil, more is not better. Too much emulsion on the face of the screen can cause difficult ink transfer and details can break down in a run. Emulsion drip from the mesh while drying is a definite indication that the coated emulsion is too thick.

Your emulsion manufacturer can recommend a coating procedure for each mesh count using a rounded or sharp coating edge.

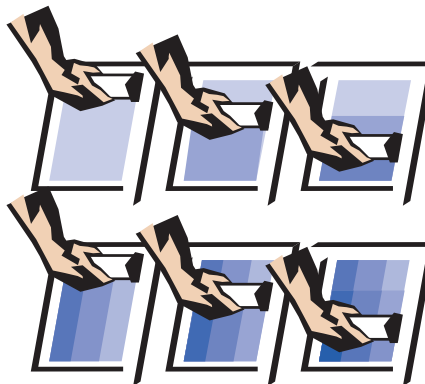

Fig. 2

The step coating procedure (Fig. 2) is used to coat a screen to find your best coating technique for that mesh count. The step coating procedure starts with a stroke on the face of the mesh. Then

coat the squeegee side once over the entire screen. Coat again the squeegee side on only two thirds of the screen, then coat again one third of the squeegee side (all wet on wet).

Dry your screen as normal. When dry, face coat with the sharp edge of the squeegee two thirds of the screen from a crossing direction (perpendicular) then dry face up. When the screen is dry apply the last coat of emulsion on the face side covering only one third of the same direction as the last face coat, then dry. With the face coatings there will be nine examples of coating thicknesses. Pick an exposure time that fits the median coating technique and expose the screen with a test positive that covers all of the coating changes.

Wash out and dry as normal. Now you can view the emulsion with a loop or microscope. Inspect the changes in thickness, then print with this screen and inspect the printed results. With the printed results compared to the visual inspection, the best coating technique for that mesh count can be determined. Standardized mesh thread thickness and weave for each mesh count is needed for consistent and reliable results.

The step coating procedure can be used while eliminating some of the steps, or replace the face coatings with all wet on wet coating strokes.

All manufacturers recommend drying coated screens with the face down (squeegee side up) in a horizontal position. A slightly elevated temperature (not over 110 deg. F.), in a filtered drying room or cabinet, will dry screens in record time, often less than half an hour. A dehumidifier will drop emulsion drying time further.



Fig. 3

Once the screen is dry, direct emulsion will dry and conform to the profile of the mesh fabric causing small hills and dips in the surface. The smoothness of the dry emulsion can be measured and is represented by the term Rz value. (Fig. 3) The lower the Rz measurement number the smoother the surface.

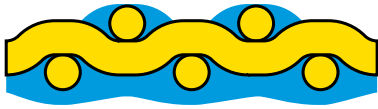

Fig. 4

Surface smoothness can affect your substrate to stencil gasket. The lower Rz numbers will be produced only by machine coating or film products. Direct/indirect and capillary films will produce the lowest Rz numbers possible for screen stencils. High solids content emulsions and face coating (second or more coats of emulsion over dry first coatings) can also lower your Rz measurements. (Fig. 4) Exact EOM and Rz numbers can only be measured by special testing equipment.

Indirect film products are presensitized emulsions on film. They are produced to expose and develop before they are attached to the screen mesh. Indirect film has fallen out of general use as products that are easier to use and have superior reproduction properties are now available.



Fig. 5

Capillary films are a photosensitive emulsion layered onto a film backing. (Fig. 5) The name is indicative of the action that causes the adhesion, capillary action. With wet screen fabric the film will draw into the mesh when placed in contact with the face of the screen.

Capillary films suffer from past bad reputation for delamination (Fig. 6) the current products available are capable of long runs and excellent detail. Capillary films produce the lowest Rz numbers possible and can save large amounts of screen room production time.

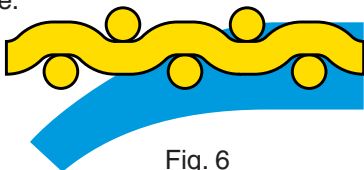

Fig. 6

Capillary films are best applied with the

(emulsion up) on a hard flat surface. (Fig. 7)

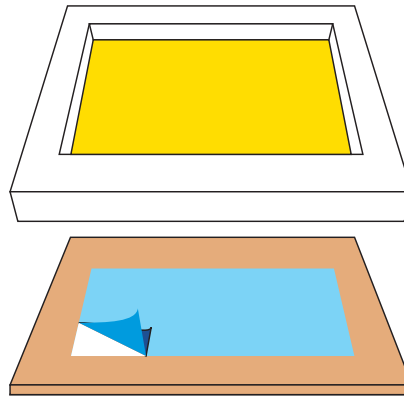

Fig. 7

Place a screen (squeegee side up) onto the film, lightly mist the mesh with a spray gun until the screen starts to draw up the capillary film into the fabric. (Fig. 8)

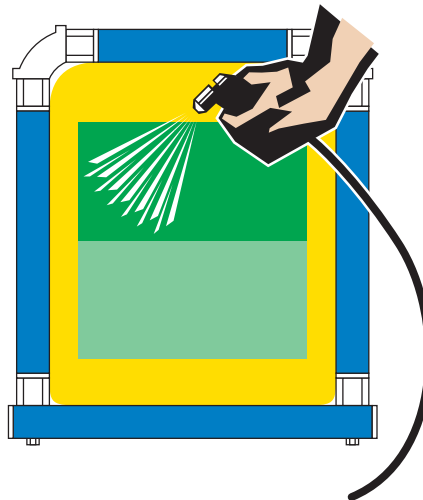

Fig. 8

Direct/indirect film products (combination stencils) are two-part film and emulsion combinations. Films assure low Rz numbers and high detail print quality. Direct emulsions produce high stencil durability. Direct/indirect film systems combine the best features of direct emulsion and film products, creating a strong, high definition stencil that will make longer runs possible with direct emulsion.

Direct/indirect film products require a coating of direct emulsion. Then the film can be adhered to the face (substrate side) of the screen. One method is to coat the screen (one stroke on each side of the screen) then place the screen (squeegee side up) on the film (emulsion side up) and stroke the squeegee side of the screen with a low

pressure stroke with a soft squeegee. (Fig. 9) The use of newsprint on your work surface will help with clean up.

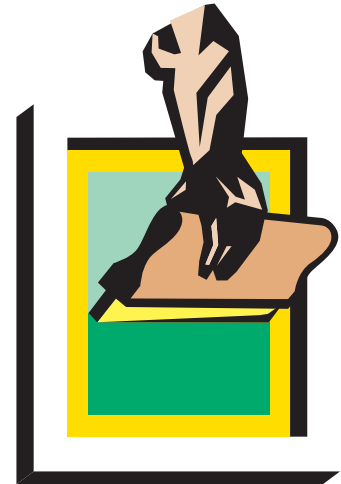
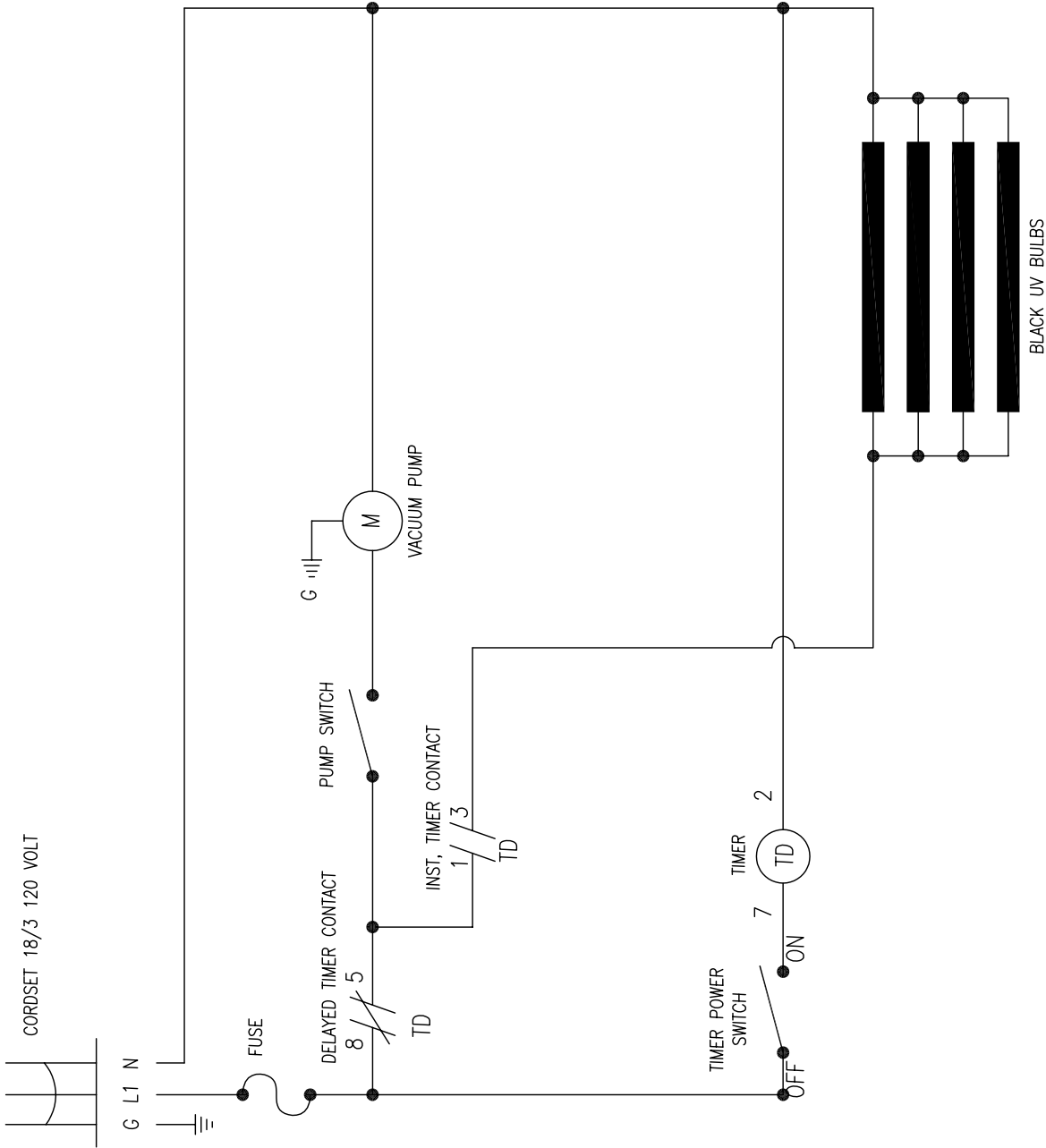

Fig. 9

Stay consistent and you will be able to predict your results with greater accuracy. Your goal should be consistency, predictability, and repeatability.

Graphics and text copyright 2002 Douglas Grigar dgrigar@hotmail.com



LEGEND

DESCRIPTION	PART NO.
BULBS BLACK UV (20 WATT)	04-08-006
(OPTIONAL) BULBS BLACK UV (40 WATT)	04-08-040
CORDSET 18/3 120V	04-03-013
FUSE 5A MDA	04-03-026
FUSE HOLDER	04-03-020
PUMP VACUUM	04-02-040
PUMP SWITCH	04-01-019
TIMER ANALOG (TD)	04-01-085
TIMER BASE 8 PIN	04-08-004
TIMER POWER SWITCH	04-01-019

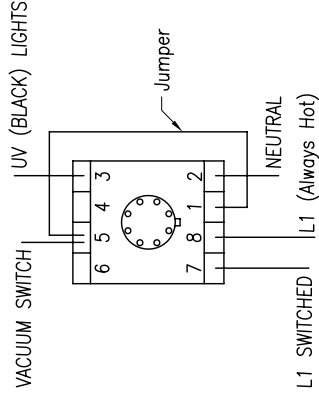

TIMER CYCLE

DELAYED TIMER CONTACT IS NORMALLY CLOSED, OPENS ONLY AT END OF TIMED CYCLE
 TIMER RESETS BACK TO CLOSED AFTER EXPOSE SWITCH IS OPENED, (TURNED OFF)
 INST. TIMER CONTACT IS NORMALLY OPEN, CLOSURES WHEN EXPOSE SWITCH IS CLOSED (TURNED ON)

		TITLE:	
		LADDER DIAGRAM	
BY:		DATE:	
DRAWN:		MVAS 10/20/00	
CHECKED:			
APPROVED:			
EXPOSIT E1000 120 VOLT 60HZ		ELECTRICAL DRAWINGS	
SIZE: C		DRAWING NO.: 02-04-011	
SCALE: NONE		REV#: -	
		SHEET 1 OF 1	

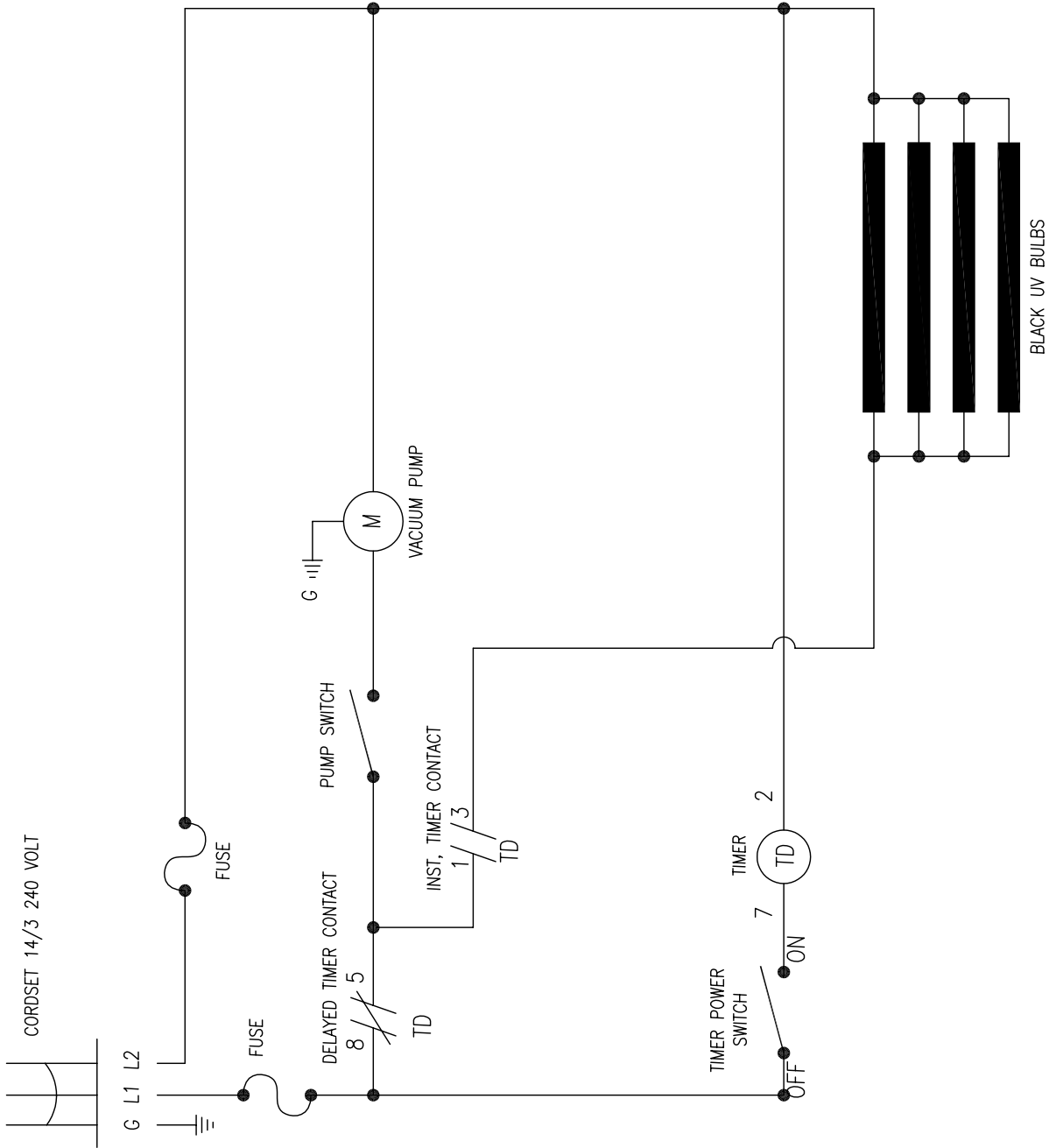

LEGEND

DESCRIPTION	PART NO.
BULBS BLACK UV (20 WATT)	04-08-006
BULBS BLACK UV (40 WATT)	04-08-040
(OPTIONAL)	
CORDSET 14/3, 240V	04-03-011
FUSE 5A MDA	04-03-026
FUSE HOLDER	04-03-020
PUMP VACUUM	04-02-041
PUMP SWITCH	04-01-019
TIMER ANALOG (TD)	04-01-085
TIMER BASE 8 PIN	04-08-004
TIMER POWER SWITCH	04-01-019

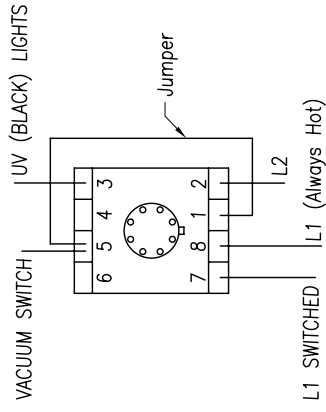

TIMER CYCLE

DELAYED TIMER CONTACT IS NORMALLY CLOSED, OPENS ONLY AT END OF TIMED CYCLE
 TIMER RESETS BACK TO CLOSED AFTER EXPOSE SWITCH IS OPENED, (TURNED OFF)

INST. TIMER CONTACT IS NORMALLY OPEN, CLOSES WHEN EXPOSE SWITCH IS CLOSED (TURNED ON)

		TITLE	
		LADDER DIAGRAM	
BY		DATE	
DRAWN		CAD	
CHECKED		SCALE: NONE	
APPROVED		SHEET 1 OF 1	
EXPOSIT E1000 240 VOLT 60HZ		DRAWING NO. C 02-04-012	
ELECTRICAL DRAWINGS		REV# -	

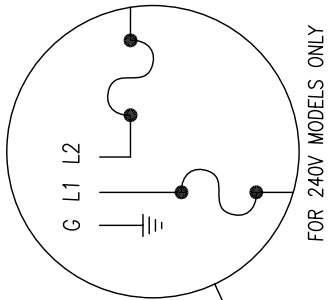
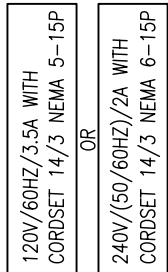

LEGEND

DISCRIPTION	PART NO.
BULBS BLACK UV (40 WATT) 28"	04-08-050
120V ONLY CORDSET 14/3 120V	04-03-133
240V ONLY CORDSET 14/3 240V	04-03-011
FUSE 5A MDA	04-03-026
FUSE HOLDER	04-03-020
120V ONLY PUMP VACUUM 120V	04-02-040
240V ONLY PUMP VACUUM 240V	04-02-041
PUMP SWITCH	04-01-019
PUMP RELAY 5A "ICE CUBE"	04-01-070
PUMP RELAY SOCKET	04-01-071
120V ONLY TIMER DIGITAL (TD)	04-01-083
240V ONLY TIMER DIGITAL (TD)	04-01-084
TIMER BASE 8 PIN	04-08-004
TIMER POWER SWITCH	04-01-019
BALLAST	04-01-052

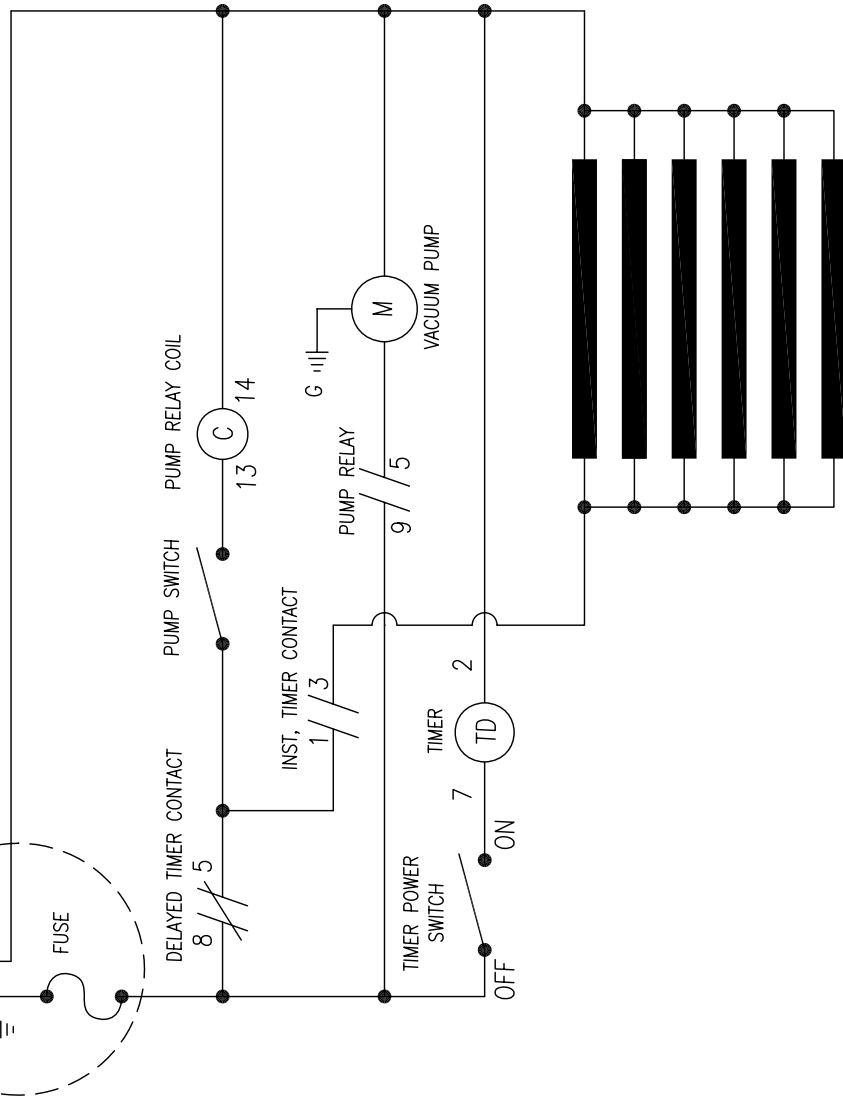

TIMER CYCLE

DELAYED TIMER CONTACT IS NORMALLY CLOSED, OPENS ONLY AT END OF TIMED CYCLE
 TIMER RESETS BACK TO CLOSED AFTER EXPOSE SWITCH IS OPENED, (TURNED OFF)
 INST. TIMER CONTACT IS NORMALLY OPEN, CLOSES WHEN EXPOSE SWITCH IS CLOSED (TURNED ON)

VASTEX INTERNATIONAL

SCREEN PRINTING
MACHINERY
SPACE RIGS
VASTEX.COM

TOLERANCES UNLESS OTHERWISE SPECIFIED

XXX .XX .X	X
DECIMAL	$\pm 0.015 \pm .032$
FRACTION	$\pm 1/16$
ANGLE	$\pm 1^\circ$

125

BT DATE
DRAWN MIKE 7/10/08
CHECKED
APPROVED

TITLE: LADDER DIAGRAM
EXPOSIT E2331 120V & 240V
ELECTRICAL DRAWING

SIZE C 02-04-013-0
DRAWING NO.

SCALE: NONE

SHEET 1 OF 1

02-04-014

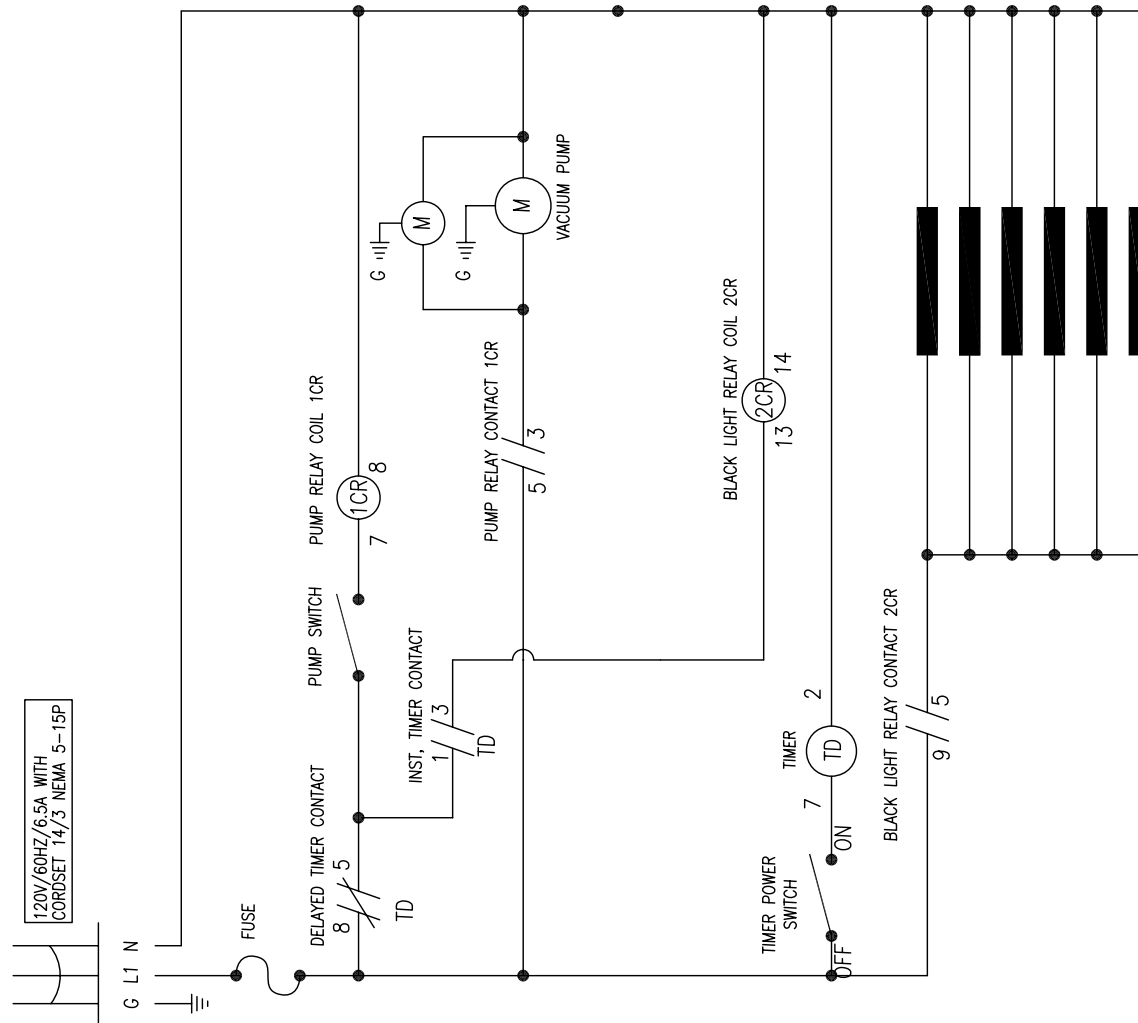

TIMER CYCLE
 DELAYED TIMER CONTACT IS NORMALLY CLOSED, OPENS ONLY AT END OF TIMED CYCLE
 TIMER RESETS BACK TO CLOSED AFTER EXPOSE SWITCH IS OPENED, (TURNED OFF)
 INST. TIMER CONTACT IS NORMALLY OPEN, CLOSES WHEN EXPOSE SWITCH IS CLOSED (TURNED ON)

LEGEND

DESCRIPTION	PART NO.
BULBS BLACK UV (40 WATT) 28"	04-08-050
CORUSET 14/3 120V	04-03-133
FUSE 10A MDA	04-03-028
FUSE HOLDER	04-03-020
LIGHTS RELAY	04-01-070
PUMP VACUUM	04-02-040
PUMP SWITCH	04-01-019
PUMP RELAY 10A "ICE CUBE"	04-01-100
PUMP RELAY SOCKET	04-01-102
LIGHTS RELAY SOCKET	04-01-071
TIMER DIGITAL (TD)	04-01-083
TIMER BASE 8 PIN	04-08-004
TIMER POWER SWITCH	04-01-019

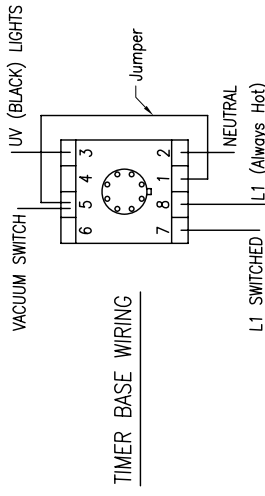

ELECTRONIC BALLAST WIRING

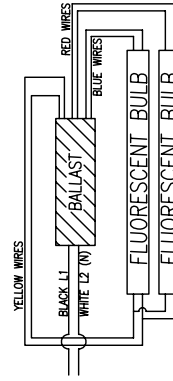

VASTEX ALLENTOWN PA. USA	
TITLE: LADDER DIAGRAM	
EXPOSIT E4731 120 VOLT	
ELECTRICAL DRAWINGS	
BY: MIKE	DATE: 7/10/08
DRAWN: MIKE	SIZE: C
CHECKED:	DRAWING NO.: 02-04-014
APPROVED:	REV#: -
SCALE: NONE	SHEET 1 OF 1

Vastex Warranty

Doc#01-00-005B Revised 10/15/07

(1.) Vastex, hereinafter referred to as “seller” warrants only to its original “purchaser”, who holds a copy of the original invoice and is the original end user of the equipment in question, its new equipment against defects in materials or workmanship on a pro-rated basis. Warranty period begins from date of shipment to the buyer and will only apply to customers paid in full. Warranty periods are as follows: one (1) year for E-1000, and V-1000, three (3) years for all other equipment (including F-Flash), ten (10) years for infrared heaters (excluding F-Flash) installed by Vastex in a new dryer, three (3) years for replacement infrared heaters, and one (1) year for replacement parts. Rubber blankets, light bulbs and glass on exposure units are particularly subject to wear while in use. Wear is not covered by this warranty but as stated above only manufacturers defects are covered. All sales made through Vastex dealers must be certified by that dealer before a warranty replacement is issued.

(2.) This warranty is expressly contingent upon the buyer delivering to seller, at the address below, with all transportation charges prepaid, the part or parts claimed to be defective within the above mentioned warranty periods stated in paragraph one. The defective part or parts will be repaired or replaced at the discretion of Vastex International, Inc. If the equipment in question is less than one (1) year old, it will be shipped to the customer at no charge, with an RGA issued by Vastex for the defective part. The defective part must be shipped back to Vastex freight prepaid within 30 days or the account will be billed. If the equipment is more than a year old, the part will be shipped after we receive the defective part. If it's necessary to expedite the movement of parts and to minimize down time to the buyer, the replacement part shall be supplied on a C.O.D. basis. If testing and analysis of said part by the seller or its supplier discloses that said part is defective, the cost of said part will be refunded to the buyer on a prorated basis.

(3.) Except as otherwise provided herein, the equipment is being sold “as-is”. Final determination of the suitability of the equipment for the use contemplated by the buyer, is the sole responsibility of buyer, and seller shall have no responsibility in connection with the suitability.

(4.) All warranties implied by law, including the implied warranties of merchantability and fitness are hereby limited to workmanship and defective parts to a warranty period stated in paragraph one. The express warranty and remedies contained herein and such implied limited warranties are made solely to the sole warranties and remedies and are in lieu of all other warranties, guarantees, agreements, and other liabilities, whether express or implied, and all other remedies for breach of warranty or any other liability of seller, in no event shall seller be liable for consequential damages.

No person, agent, distributor, or service representative is authorized to change, modify or extend the terms hereof in any manner whatsoever.

These terms and conditions are an essential part of the transaction between the parties and constitute the entire agreement between them with respect to the same.

Some states do not allow limitation on how long an implied warranty lasts of the exclusion or limitation of incidental, or consequential damages, so the above limitation may not apply to you.

This warranty gives you specific legal rights, and you may also have other rights which vary from state to state.

Infrared heaters are the only replacement parts covered for a period of (3) years from date of shipment and contingent to receipt of payment in full.

Electrical components can not be returned once installed unless proven defective.
Please refer to doc. 01-01-006 for warranty implementation help.
Please refer to doc. 01-00-015 for specific terms and conditions of sale and the limited warranty.
Please refer to doc. 01-00-017 for V-2000HD printer warranty.

F:\Shared\Vastex\01-Manuals & Doc\00-misc\01-00-005B_Warranty.doc

VASTEX WARRANTY IMPLEMENTATION SHEET

Please read this document in order to fully understand the warranty.

Doc.# 01-00-006

Your new Vastex equipment is protected against *manufacturers' defects by our warranty, completely explained in doc# 01-00-017 for the V2000-HD series manual printer and in doc# 01-00-005 for all other Vastex manufactured equipment. Please refer to these documents for the **warranty term and specific concerns about the warranty. The following are some important facts and requirements for the proper implementation of the warranty.

1.0 Everything is covered!

2.0 **Warranty Term is defined as: Ship date from VASTEX to the date the item in question is returned to VASTEX for inspection and repair.

3.0 *Manufacturers defects are defined as: Parts determined to be defective in workmanship which will lead up to a premature failure. The determination will be made only by the manufacturer of the item in question.

4.0 To take advantage of the warranty the following steps must be taken:

4.1 The equipment must be paid for in full.

4.2 The item in question must be shipped to VASTEX for evaluation with all shipping costs incurred by the buyer.

4.3 If the item is deemed as a manufacturer's defect it will be repaired or replaced within 2 business days from the time received. The shipping cost back to the customer located in the continental United States will be paid by VASTEX if a warranty item.

4.4 **If the item in question must be replaced immediately and is more than a year old, it will have to be purchased at list price and will be shipped COD. A pro-rated credit will be given promptly if the returned item is a valid manufacturer's defect.**

4.5 If the equipment was shipped less than a year before the date of the service call and a technician confirms the part needed for repair, the replacement will be shipped before the replacement is shipped back. An RGA will be issued and must accompany the old part to VASTEX within 30 days or the account will be billed.

5.0 Important facts about the condition of shipped equipment:

5.1 Dryers are partially assembled with the belts tracked and the machine run at full temperature for a min. of 1 ½ hours.

5.2 Printers are partially assembled, inspected, and adjusted for all heads down prior to partial disassembly and packing.

5.3 Exposing units are fully assembled and tested with the maximum screen size for vacuum integrity, timer operation and light output.

6.0 This document is in addition to the standard warranty and only helps the customer understand how to take advantage of the warranty. In no way does this document override the standard warranty or the terms and conditions of sale and the limited warranty doc# 01-00-015.

Please see doc# 01-00-015 for specific terms and conditions of sale and the limited warranty

VASTEX
INTERNATIONAL

1032 N. IRVING ST.
ALLENTOWN PA. 18109 USA

Vastex International, Inc.

TERMS AND CONDITIONS OF SALE AND LIMITED WARRANTY Doc.#01-00-015

1. Buyer's order will constitute an offer in accordance with the terms hereof and such offer, upon acknowledgment of Seller, will constitute the agreement between Buyer and Seller. Buyer's order after such acknowledgment by Seller will not be subject to cancellation, change or reduction in amount, or suspension by Buyer of deliveries, unless prior to such action Buyer has obtained Seller's written consent. Notwithstanding anything to the contrary in Buyer's Purchase Order or other communications, the parties agree to be bound by these Terms and Conditions. Acceptance of the product by the Buyer shall be deemed to constitute unconditional acceptance of these Terms and Conditions.
2. Any of these terms, conditions and provisions of Buyer's order which are inconsistent with Seller's acknowledgment and these Terms and Conditions of Sale shall not be binding on the Seller and shall be considered not applicable to any sale so made. No waiver, alteration or modification of any of the provisions on either side of the document shall be binding upon Seller unless agreed to in writing by Seller.
3. (a) All prices are F.O.B. Seller's Plant and method of delivery and routing shall be at Seller's discretion, unless specifically otherwise stated herein. Notwithstanding any agreement to pay freight, delivery of products purchased hereunder to a common carrier or licensed trucker shall constitute delivery to Buyer and be determinative of the date and time of shipment and all risk of loss or damage in transit shall be borne by Buyer. If the Buyer fails to accept the goods from the common carrier or licensed trucker, the Seller shall be entitled to claim payment from the Buyer. Seller shall arrange for storage, the risk and the cost, including insurance costs, to be borne by the Buyer (and Buyer agrees to pay such amounts upon demand) except if the failure to accept delivery is due to any of the exceptions noted in Paragraph 4.

(b) Terms of payment shall be as stated on invoice.
4. It is understood that deliveries will be made in accordance with Seller's regular production schedule. Every reasonable effort will be made to meet the Buyer's required delivery dates but Seller will not be liable for damages or be deemed to be in default by reason of any failure to deliver or delay in delivery due to any preference, priority, allocation or allotment order issued by the Government, whether Federal, State or local, or causes beyond its control including but not limited to, Acts of God or a public enemy, acts of Government, fires, floods, epidemics, quarantine restrictions, strikes, lockouts, freight embargoes, severe weather, unavailability of materials or shipping space, delays of carriers or suppliers or delays of any subcontractors. Should delay in delivery be caused by any of the circumstances mentioned in this paragraph, such extension of the delivery period shall be granted as is reasonable under the circumstances of the case. Should delay be caused by an event not specifically mentioned in this paragraph, damages will be limited to cancellation of the purchase order without penalty, and refund of any monies deposited or prepaid on the purchase order with no liability for any consequential or incidental damages.
5. Seller reserves the right to increase the prices prior to Seller's acceptance of order and/or after expiration of any price quoted by Seller.
6. Unless otherwise stated in writing, Seller's prices do not include sales, excise, value-added or other taxes. Consequently, in addition to the price specified herein, the amount of any present or future sales, use, excise, value-added or other tax applicable to the manufacture, sale, purchase or use of the products hereunder shall be paid by Buyer, or in lieu thereof, Buyer shall provide Seller with a valid tax exemption certificate acceptable to the taxing authorities.
7. Seller reserves the right, at any time, to revoke any credit extended to Buyer because of Buyer's failure to pay for any products when due or for any other reason deemed good and sufficient by Seller and in such event, all subsequent shipments shall be paid for prior to at delivery at Seller's option.
8. (a) SELLER'S LIABILITY SHALL BE LIMITED TO SELLER'S STATED SELLING PRICE PER UNIT OF ANY DEFECTIVE GOODS AND SHALL IN NO EVENT INCLUDE BUYER'S MANUFACTURING COSTS, LOST PROFITS, GOODWILL, OR ANY OTHER SPECIAL, INDIRECT, INCIDENTAL OR CONSEQUENTIAL DAMAGES, ARISING OUT OF THE AGREEMENT, THIS CONTRACT, THE SALE OF THE PRODUCTS TO THE BUYER OR THE USE OR THE PERFORMANCE OF THE PRODUCTS. Seller may at its discretion repair, replace or give the Buyer credit (pro-rated) for such defective products.

(b) Notwithstanding anything herein to the contrary, Seller shall have no liability for alleged defects with the products which are not specified in written notice from the Buyer to the Seller within thirty-six (36) months from the date of shipment of machines. Seller shall pass to Buyer any warranty received by Seller from the manufacturer of Limited Life Components, which in most cases is 12 to 18 months.

(c) Seller shall have no liability under this Limited Warranty unless Buyer has paid in full for the products. Further, this Limited Warranty is expressly contingent on Buyer's delivery to Seller, all costs prepaid, the defective part(s) within thirty-six (36) months of shipment to Buyer, together with a written statement specifying the alleged defect(s). Any replacement part(s) shall be shipped to Buyer on a C.O.D. basis.

(d) SELLER SPECIFICALLY EXCLUDES ALL WARRANTIES, EXPRESSED, IMPLIED OR OTHERWISE, EXCEPT AS STATED EXPLICITLY IN THESE TERMS AND CONDITIONS OF SALE. SELLER DISCLAIMS THE WARRANTY OF MERCHANTABILITY AND FITNESS FOR A PARTICULAR PURPOSE.
9. The remedies herein reserved by Seller shall be cumulative and in addition to any other legal remedies. No waiver of a breach of any portion of this contract shall constitute a waiver of continuing or future breach of such provision or of any other provisions hereof.
10. These Terms and Conditions constitute the entire agreement of the parties. No amendments, changes, revisions or discharges hereof in whole or in part shall have any force or effect unless set forth in writing and signed by the parties hereto. This contract shall not be assignable by Buyer voluntarily by operation of law or otherwise without Seller's written consent.
11. This contract shall be governed and shall be construed according to the domestic laws of the Commonwealth of Pennsylvania.
12. Anything herein to the contrary notwithstanding, any action for alleged breach by Seller of the contract between the parties, including but not limited to any action for breach of the warranties herein set forth, shall be barred unless commenced by Buyer within one (1) year from the date such cause of action accrued.
13. This agreement shall inure to the benefit of and be binding upon the parties hereto, their respective successors and permitted assigns.
14. **All notices required by this contract to be given by either party shall be sent in writing or by facsimile and shall be addressed to the last known address of such other party. Notices shall be deemed to have been received on the fifth business day following deposit in the mail.**