

VASTEX

SCREEN PRINTING EQUIPMENT

EconoRed-II-Series Dryers

Assembly, Operating, and Maintenance Instructions for all
EC-II-30 and EC-II-54 Dryers



(EC-II-30 Shown)

	Pg #
• Introduction / Safety	2
• Assembly	3-5
• Component Identification	6-7
• Operation	8-9
• Maintenance	10
• Troubleshooting	11-12
• Dryer & Exhaust Hood Ducting	13
• Warranty/Terms & Conditions	14-16

Electrical Drawing #: _____ Rev: _____

Serial Number: _____ Date: ___/___/___

(Please log your machine's serial number and date of purchase for future reference.)

Vastex International, Inc.
1032 N. Irving St.
Allentown, Pa. 18109 USA
Phone# 610 434-6004 Fax# 610 434-6607
Web Site www.vastex.com
E-Mail info@vastex.com

Introduction

Congratulations, you have chosen a VASTEX conveyor curing system. VASTEX has been designing and building dryers since 1960 and has the knowledge and expertise to supply a quality dryer and help you keep it running for years to come. VASTEX has innovated many of the features found in conveyor ovens today from control methods, modular features, air movements and belt tracking.

Your Vastex Infrared Dryer has been Factory tested and burned in for a period of 2-8 hours. All components are tested to be sure they work correctly when the Dryer leaves our factory.

Safety

The Instruction Manual and Safety Instructions must be read and understood by anyone operating the Vastex Conveyor Drying System.

- The operator should read and understand the instruction manual before operating this equipment. Store instruction manual and safety instructions near equipment for easy access to operators.
- VASTEX Conveyor Drying System is intended for the curing of non-flammable inks on screen printed materials. Do not use for any other purpose unless authorized by Vastex International, Inc. Use of this equipment for any other purpose can be dangerous and may cause damage to this equipment and voiding the warranty.
- It is recommended that the area around this equipment be designated as a work area and only authorized employees be allowed in the area.
- Children and pets must be kept clear of the work area.
- Do not place any objects on top of the drying chamber. Surfaces are hot!
- Never leave equipment unattended.
- Do not operate conveyor or dryer with any cover or guard removed.
- Operator must be familiar with controls of the dryer and conveyor.
- Never put excessive load on the conveyor belt.
- Before starting production, the operator must check that all covers and guards are in place, no material has been left on the conveyor, and the work area is clear of obstructions.
- Switch on and verify conveyor belt is moving before turning on the heat.
- Allow dryer to cool to 300°F (149°C) before switching off conveyor.
- Always turn off power at the main disconnect at the end of production.
- In case an abnormal symptom occurs, for example excessive vibration, noise, and strong smell or smoke development, turn off the VASTEX Conveyor Curing System and contact a qualified technician.
- Immediately turn off the VASTEX Conveyor Curing System if products become jammed in the drying chamber or conveyor belt.
- Do not remove any cover or guard until power at the main disconnect is switched off and locked out. No unauthorized persons are to be allowed inside the control boxes.
- Turn off and lock out power at the main disconnect before any cleaning or maintenance.
- Only qualified technicians should be allowed to make repairs on the VASTEX Conveyor Drying System.

Assembly

Tools Needed: (1) Crowbar or Claw Hammer, (2) 9/16" open end wrenches, (1) 7/16" open end wrench or socket, (1) 1/4" nut driver or flat blade screw driver

- 1) Dismantle the crate that your dryer came in. Remove the top and sides with a crowbar or claw hammer.

- 2) Remove the front and rear conveyor sections and belt from the pallet and set aside.

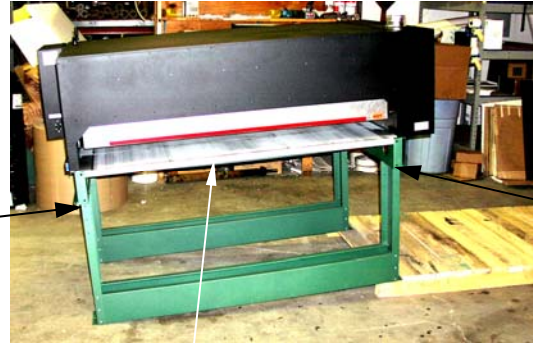

Conveyor Side

Conveyor Side

DO NOT LIFT FROM CONVEYOR BED

- 3) Carefully slide the dryer and conveyor assembly off the pallet and onto the shop floor.

**Lift from Conveyor Sides only.
Do not lift from Conveyor Bed!**

Caution! The heating chamber sits on top of the conveyor on 4 pins. Lifting the chamber will separate the chamber from the conveyor.

- 4) Position front end section (section without motor) on the floor in the front of the dryer as shown. Locate 3/8 bolts, flat washers, lock washers, and nuts from hardware bag. Two 9/16" wrenches are required. Raise one side and attach with hardware as shown below through the upper mounting hole. Do not tighten at this time. Carefully raise the other side and insert both upper and lower bolts, washers, and nuts. Install remaining bolt on first side and tighten all bolts. Use the same procedure for installing rear end section. Be sure all end section mounting bolts are tight before continuing.

Front of dryer shown



Control Box

Mounting holes

Front end section (without motor)

Mounting face for end section.

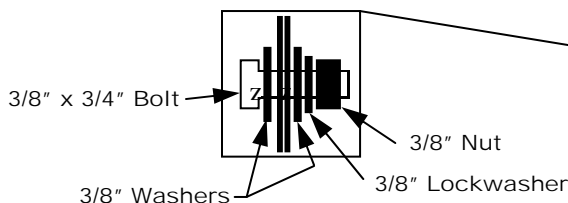

Assembly (cont'd)

- 5) The belt needs to be installed as shown in the diagram below. Be sure the belt is routed over all braces on the conveyor and over the Aligner. To connect your belt, align the Alligator Lace and install the pin. Some belts will have a plastic flap over the Alligator Lace. Position it as shown in the diagram.

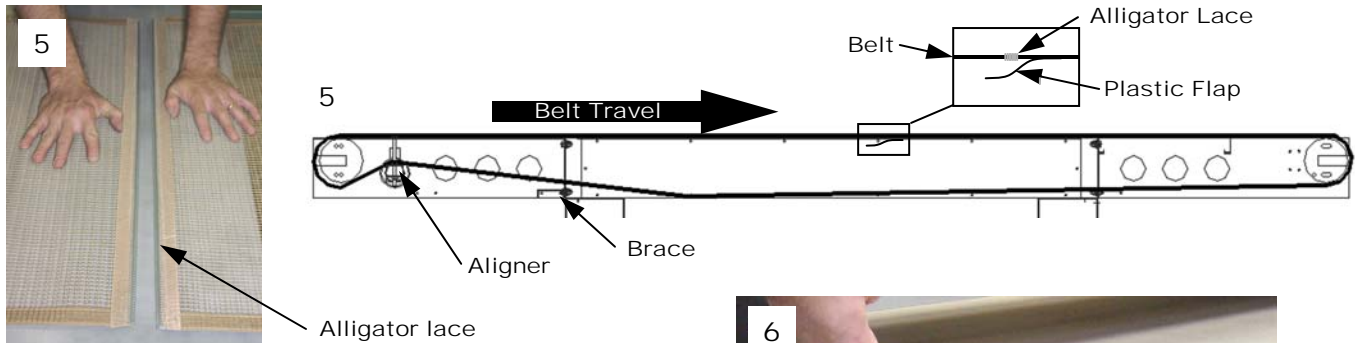

- 6) The belt needs to be tightened and adjusted. To tighten and adjust the belt, use the Aligner Bolts. To raise the Aligner, turn the Aligner Bolt clockwise with a 7/16" wrench. To lower it, turn it counter clockwise. Start with the belt centered on the pulley.

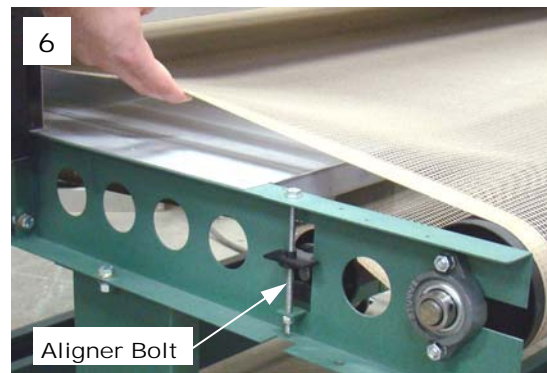

- 7) Install the crank handle onto the shaft on top of the chamber. Align set screw to the flat on shaft and tighten with 1/8" allen wrench. Raise heaters to full up position.
- 8) The 4" exhaust stack should be vented outside. Exhaust ducting should not restrict air flow. Ducting should create no more than 10% decrease in exhaust CFM. See **Dryer and Exhaust Hood Ducting** for more information.

(Note: Restricting the dryers exhaust can affect the operation of the dryer causing excessive heat buildup within the chamber and fumes to fill the chamber and work area. The excessive heat buildup in the chamber may damage the dryers exhaust blower. Proper venting is important.)

- 9) Have a licensed electrician complete the electrical hook-up and fill out the warranty card. Send it back to Vastex to validate your warranty. A wiring diagram has been included with this manual. One is also adhered to the inside of the control box cover.

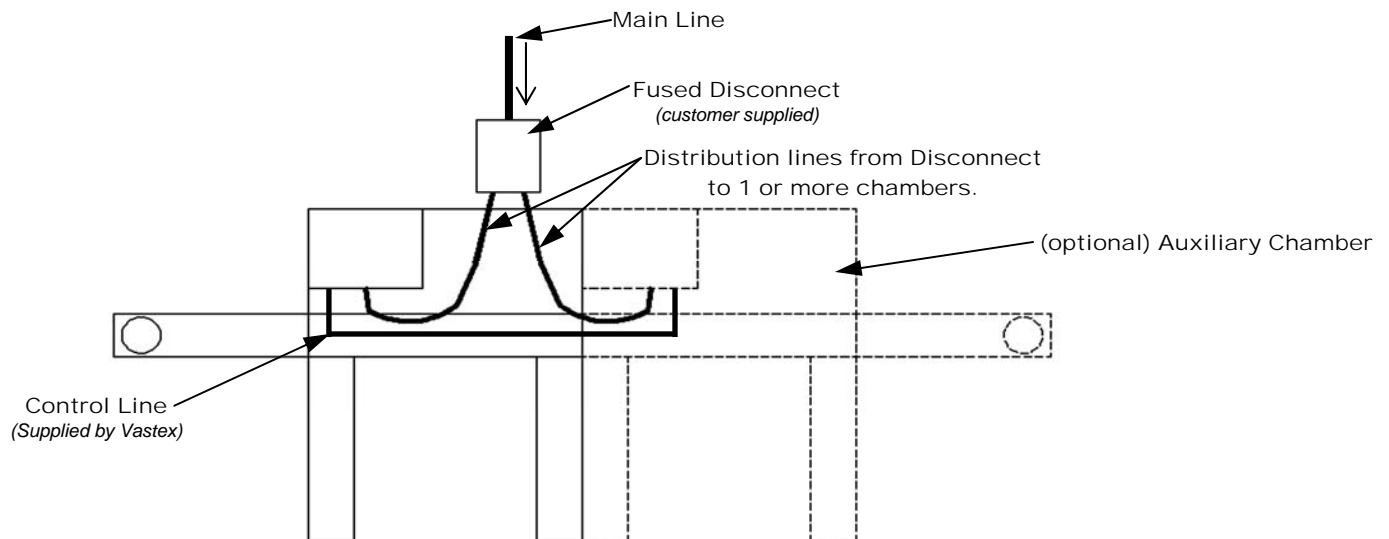

- 10) Plug the wire from the conveyor motor into the rear of the control box. See Photo on Pg.3
- 11) Turn on the system switch and then the belt speed control. See **Dryer Operation– Startup Procedure**. Check that the belt is moving and running in the center of both pulleys. If belt is tracking in the center of the pulley, dryer is ready for use. If tracking is required, see below.
- 12) For shops with less than 240V service, please Autotune your controller. This procedure can be found in the **Troubleshooting** section.

13) **Belt Tracking**

(Move in small increments while belt is moving. Do not leave conveyor running unattended.)

- If the belt is slipping, add belt tension by raising equally both sides of aligner roller. 1"-2" of belt sag at the bottom side is desirable. To raise roller turn adjustor screw clockwise.
- **Belt moving to the left**, raise left side of aligner by turning adjustor screw clockwise 1/2 turn at a time.
- **Belt moving to the right**, raise right side of aligner by turning adjustor screw clockwise 1/2 turn at a time.
- If belt is tracking off center at the drive roller, slightly loosen bearing bolts, (2) 1/2" wrenches needed. Turn adjustor screw clockwise to move belt toward motor end of pulley and counter clockwise to move belt away from motor end of pulley, retighten all bolts. Recheck belt tracking at front end.

Note: Do not over-tighten belt, 1" to 2" belt sag is desirable.

Belt aligner pulley Adjustor screw

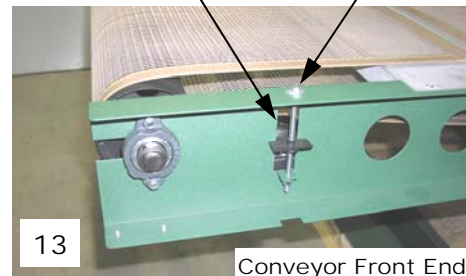

Bearing bolts Drive roller adjustor

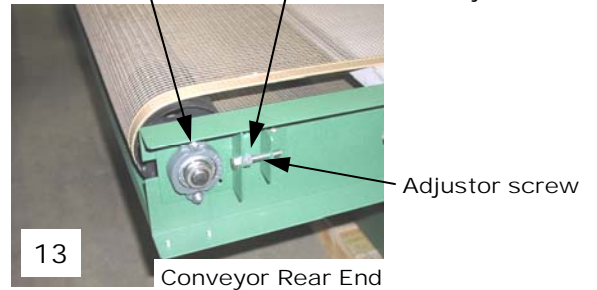

Component Identification



(EC-II-30 Shown)

Chamber Components

- IR Heater** The infrared heaters in VASTEX dryers emit medium wave infrared heat, perfect for curing plastisol inks. The heater connections are located in the trough on the right side of the heater, connected with high temperature terminals and stainless steel socket head cap screws.
- J Sensor** Vastex uses a mineral insulated "Type J" Thermocouple mounted under the first heating element on the right side. It is shielded to provide a near "closed loop" control system. The sensor reacts very quickly to heater changes and is designed to be aware of changes in the chamber's environment. The sensor is wired to the Digital Temperature Controller found on the control panel. *Refer to wiring diagram when replacing "J" Sensor. (if SBER is displayed on controller, "J" Sensor is malfunctioning)*
- Control Box** The Control Box contains most electrical components and is designed for easy maintenance. Connections should be checked after the first (3) months of use and every (6) months after. More information on the Control Box and Control Panel found in section **Controls**.
- Crank Handle** Used to raise and lower IR Heater assembly. Turning the handle clockwise raises the elements, counterclockwise lowers them. Vastex dryers use three variables to control the curing process, 1) Belt speed, 2) Temperature and 3) Heater height (Heater Focusing).
- Exhaust Stack** 4" exhaust stack. See Dryer & Exhaust Hood Ducting for proper venting. **(Note: Restricting the dryers exhaust can affect the operation of the dryer causing excessive heat buildup within the chamber and fumes to fill the chamber and work area. The excessive heat buildup in the chamber may damage the dryers exhaust blower. Proper venting is important.)**
- Filtered Intake** Filters the incoming air. Clean or replace this filter often and as needed, replacement filters p/n (06-22-040)

Conveyor Components

- Belt** The conveyor belt is made of Teflon coated fiberglass. It is joined together with an alligator lace using a steel pin to connect each side. The belt will not burn under normal conditions, but the dryer should always have the belt moving while the heaters are above 300 degrees. The belt should remain tracked in the center of each pulley. (See "Belt Installation and Tracking" for adjustment instructions.)
- Aligner** The aligner is a device for tracking the belt and keeping it on the pulley. As the belt moves from side to side the aligner is used for adjustments to keep it centered. The belt does not have to be perfectly centered on the pulley but should not be hanging over either edge.
- Pulley** The pulleys at either end of the conveyor are made by VASTEX of 4 ½ inch steel tubing with ¾ inch center shaft. They are mounted on self aligning flange bearing blocks for precision rolling.
- Gear Motor** A 130 Volt DC gear motor is located to the rear of the conveyor. It drives the rear pulley and belt with a roller and a #35chain. Replacement part numbers can be found on your dryer's wiring diagram.

Controls

Heat Switch: Controls power to heater only.

Temperature Control: Microprocessor Based PID Controller. Two digital readouts, top digital readout is the "Process Value" (PV), temperature at the sensor, bottom readout is the "Set Value" (SV), the temperature you set. All values are in Fahrenheit degrees standard but can be changed to Celsius. Four buttons along the bottom of the control unit, the two outside oval shaped are for setting operating parameters. (Factory set! Do not attempt to alter without consulting a VASTEX factory rep.) The two buttons in the middle, the "up arrow" and the "down arrow," are for adjusting the "Set Value"(SV). A green light (CON) will illuminate when the controller is calling for heat (output on). A red light (ALM) will illuminate when the actual temp is higher than the set value.



Heater Light: This 6 volt WHITE pilot light is wired to the IR Heaters. One light per heater is used. These lights indicate when electricity is flowing through the each heater.

Relay Output Light: This 250 volt RED pilot light is wired to the output side of the relay. This light will cycle on & off with the control output light. It verifies that the relay is working properly. Units over 250V may not use these lights.

Control Output Light: A 250 volt GREEN pilot light is wired to the output side of the temperature controller. This light should cycle on & off with the controller. It verifies that the controller output voltage is going to the relay coil.

Power Light: This light is wired to the power terminal and will be illuminated whenever power is coming into the unit. At the end of the day, the machine should be disconnected so this light is out.

DC Volt Meter: Digital Volt Meter displays, in volts, the amount of power going to the belt motor. This makes setting and adjusting belt speed much easier. A table showing the time associated with voltage can be found in **Dryer Operation**.

Belt Speed Control: An AC-DC converter is mounted to the face of the control panel which allows the operator to vary the DC volts to the motor. Standard equipment is supplied with a dial plate under the knob. The dial is for reference only and does not represent seconds in the heat.

System Switch: Controls power to Controls. Shutting this switch off does not make it safe to open the Control Box. Shut off power at main disconnect before servicing, Power Light must be out before entering any part of this machine

Components found inside control box.

SSR Relay: Your EC-II Dryer may be equipped with as many as (2) SSR (Solid State Relays) per chamber. The SSR's are the switching devices which send the power to the heaters. The relay coil is wired to lug #9 on the digital temperature controller. As the control gets a signal from the sensor, for heating or cooling, the relay opens and closes its solid state contactor to modulate power and maintain a consistent temperature. On 208V - 240V units, each relay is wired to an output light which helps to monitor their operation.

Fuses: Two system fuses, and 2 control fuses are found in the control box, and protect the internal electronics.

Dryer Operation

Control System Summary:

The control system in your dryer is called a “closed loop system”. The system includes a Digital Controller mounted to the control panel, a Sensor mounted in a shield under the heater a relay and an Infrared Heater. The digital controller is set to the desired temperature and the Sensor measures the temperature at the face of the heater. The sensor reports back to the control, and the relay switches the heat on and off to the heater.

Startup Procedure

- 1 Turn on Power on Main Disconnect:** The red Power Light will illuminate. The EC-II should be wired to a Main Power Disconnect. (Optional) Disconnect bracket available.
- 2 Check belt path:** Remove any objects from the conveyor and belt.
- 3 Turn on System Switch:** Power is sent to the heater switch and belt speed control.
- 4 Turn on Conveyor:** Set speed to desired setting.
- 5 Turn on Heat Switch:** Turn on the Temperature Controllers.

How to determine Temperature set point:

The sensor is located directly under the heater so it will read a much higher temperature than seen at the garment. Set the temperature several hundred degrees higher to compensate for this difference. A non contact heat gun can be used to read the temperature of the ink at the end of the dryer while it is still under the last heater. Take into consideration the thickness of the ink when using the heat gun. It will measure the top layer of the ink, if the ink is very thick you must add a buffer to be sure cure temperature is reached throughout the ink. Temperature set point, heater distance to the garment, and belt speed will all effect the ink temp.



Curing Plastisol with infrared:

Plastisol ink can fully cure in approximately 20-30* seconds. The ink must achieve 310°-320°F (154°-160°C) to cure and fuse to the garment. We recommend* a starting temperature 750°F (400°C), 3” heater height and a belt speed of 25 seconds in the chamber

Discharge or water based:

Water based products require more time than plastisol to cure due to the fact that the water/moisture must be evaporated before the ink can cure. We have seen cure times from 50 to 90* seconds to achieve a full cure or discharge and not damage the garment. Please note as the time is increased the temperature must be decreased to protect the garment from scorching.

***Actual cure times can vary depending on conditions such as garment moisture and color, ink color, ink thickness, and environmental conditions. All three variables should be used to maximize production while insuring a proper cure.**

- 6 Set the temperature:**  With the power on, push and hold the up arrow, the (SV) will climb. The longer you hold the button, the faster the (SV) will climb, it will start climbing by one, then ten, then hundreds. Set the desired temperature and allow approximately 15 minutes for heat up. Refer to the **trouble shooting** section for Controller Error Messages.
- 7 Set the Heater Height:**  Rotate the Hand Crank on top of the Dryer Chamber, clockwise to raise the heaters, and counter-clockwise to lower them. Set the desired heater height for your job. It is recommended to run the heater height at about 2” - 3” above the garment.
- 8 Set the Belt Speed:**  Rotate the Belt Speed Control Knob clockwise to increase speed and counter-clockwise to decrease it. Refer to the charts on the next page for “Time Through Chamber” settings. For Plastisol inks, a good starting point is 20-25 seconds in the chamber.

Volts Vs Time in Heat

Single Chamber EC-II

The chart at the right is based on... <ul style="list-style-type: none"> • A 36" Single Chamber heat zone. • 12 tooth Motor Sprocket • 24 tooth Pulley Sprocket • 130VDC, 28RPM Gear Motor Sprocket information can be found on your dryer, next to the Drive Motor.	Time Through Chamber	Volts	Time Through Chamber	Volts
	15 Sec	80 V	1 Min 29 Sec	16 V
	21 Sec	60 V	1 Min 36 Sec	15 V
	25 Sec	50 V	1 Min 54 Sec	13 V
	31 Sec	40 V	2 Min 10 Sec	12 V
	44 Sec	30 V	2 Min 20 Sec	11 V
	1Min 09 Sec	20 V	3 Min 00 Sec	9 V

Double Chamber EC-II

The chart at the right is based on... <ul style="list-style-type: none"> • A 72" Double Chamber heat zone. • 12 tooth Motor Sprocket • 18 tooth Pulley Sprocket • 130VDC, 28RPM Gear Motor Sprocket information can be found on your dryer, next to the Drive Motor.	Time Through Chamber	Volts	Time Through Chamber	Volts
	20 Sec	90 V	1 Min 25 Sec	24 V
	28 Sec	70 V	2 Min 00 Sec	20 V
	31 Sec	60 V	2 Min 15 Sec	16 V
	39 Sec	50 V	2 Min 40 Sec	14 V
	49 Sec	40 V	3 Min 05 Sec	12 V
	1 Min 05 Sec	30 V	4 Min 00 Sec	10 V

Operation Tips

- While machine is in operation, it is necessary to have the belt moving while the heater is above 300°F.
- Allow approximately 15 minutes for dryer to reach 700°F - 800°F (371° - 427°C).
- If no garments are being run through the dryer for more than 10 minutes, it is recommended to lower the heat set point to 500°F (260°C). It will take approximately 10 minutes to return to operating temperature.
- Periodically check ink temperature at the exit of the dryer. It is recommended that you check the temperature of the ink towards the outside of the printed image.
- When checking temperature with a laser gun, shoot the ink while it is still under heater

Shut Down Procedure

- 1** Turn off Heat Switch: Turn the Heat Switch off. Allow the heaters to drop to a maximum of 300°F (149°C) before turning off the conveyor.
- 2** Turn off Conveyor: **(optional)** Once the dryer cools down to 300°F (149°C) or lower, turn the Belt Speed down to the off position, skip this step if leaving the conveyor belt speed set for the following shift.
- 3** Turn off System Switch: Turn the System Switch OFF only after dryer has cooled to 300°F or lower. Verify that the only Diagnostic light still on is the Power Light.
- 4** Shut Main Disconnect: Your EC-II should be wired to a Main Power Disconnect. The dryer must be shut off via a Main Disconnect at the end of every shift. **At this point, no lights should be illuminated on the Control Box.**

Maintenance

Caution! Power must be turned off at the external disconnect, or the machine unplugged, before entering any part of this machine. The red Power Light labeled "Power" must be off!! A qualified electrician should perform any internal testing requiring power on!

- Electrical Connections** Electrical connections will loosen in time from heating and cooling. Every three (3) months the **power should be turned off** at the external disconnect, or unplugged, and all the points of connection should be inspected and tightened.
- Lint Buildup** As with your clothes dryer at home lint will build up where ever air is flowing over garments.
Every six months
-The top cover should be removed to clean around the heater and any other visible debris buildup.
-The side covering the blower box should be removed, and all lint be removed from around the exhaust blower.
-The optional exhaust blower, located on the rear of the machine, should be cleaned every **2-3 months**. To open the back panel of the exhaust blower, remove the (7) black #8 machine screws for access to the blower.
- Motor & Elevator Chain** Chains can loosen in time and should be inspected, adjusted, and lubricated when necessary. The motor chain is located in the rear of the conveyor behind the Chain Guard. The elevator chain is located inside the chamber and can be accessed by removing the lid from the top of your dryer.

Drive Chain Adjustment

- 1) To remove the chain guard, unfasten the four black sheet metal screws at the top. Be sure to replace the guard after adjustment is made.

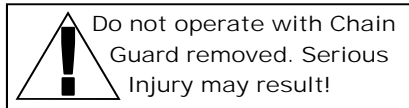

View with chain guard removed

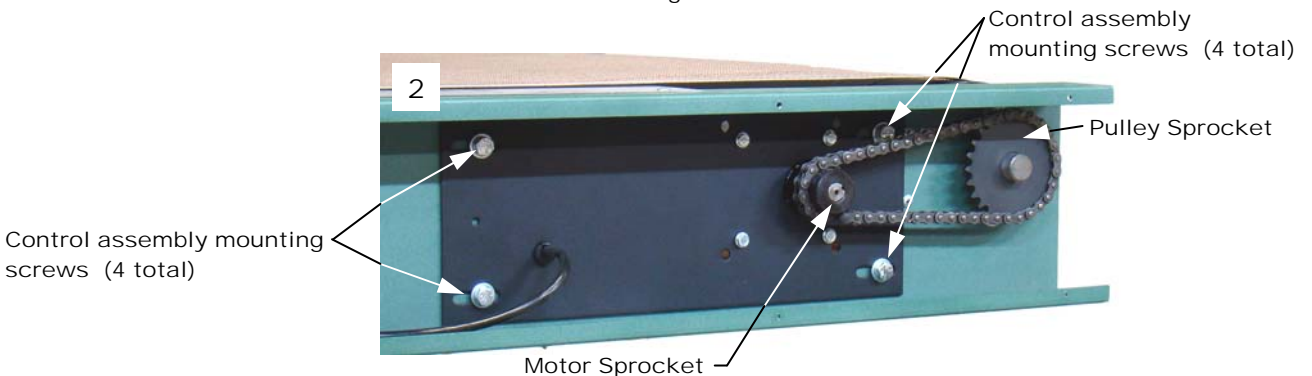

- 2) To adjust the drive chain you will need to loosen the four Control assembly mounting screws. The Drive plate is slotted to allow the entire assembly to slide left or right to loosen or tighten the chain. Adjust the chain so there is a max of 1/4" vertical movement in the chain.

CAUTION! Do not over tighten chain, damage to bearings may occur.

- 3) Check the set screws on each sprocket before re-installing the Chain guard. Set screws must be tightened with a 1/8" allen key.

Troubleshooting

Caution! Power must be turned off at the external disconnect, or the machine unplugged, before entering any part of this machine. The red Power Light labeled "Power" must be off!! A qualified electrician should perform any internal testing requiring power on!

Belt Speed Min/Max Adjustment

Setting the low speed pot adjustment: The low speed pot should be set so the belt (or sprocket) moves very slow at the lowest setting on the controller, just before the controller is clicked in the off position.

Setting the High speed pot adjustment: The high setting is set so 130 VDC is the maximum voltage to the motor, a volt meter is needed for the high speed adjustment.

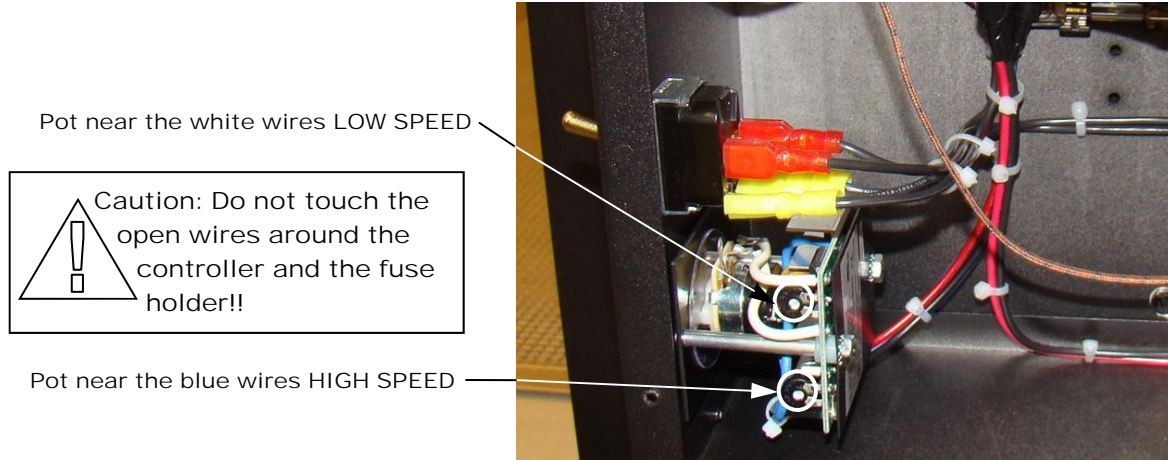

Temperature Controller

Auto Tuning Automatic Tuning has been performed at factory for all machines. Automatic Tuning must be performed by the customer for the following reasons; When equipment is other than 240v (e.g. 208v), replacing a controller, replacing a "J" sensor, and/or new heating elements. Controller set point value must be set between 650° - 700°F (343° - 371°C) before beginning auto-tuning. Start with the room temperature for accurate auto-tuning.

- Procedure:
- Press the return key for at least 6 seconds (maximum 16 seconds). This initializes the auto-tune function. (To abort auto-tuning procedure, press and release the return key.)
 - The decimal point in the lower right hand corner of the PV display flashes to indicate that auto-tuning is in progress. Auto-tune is complete when flashing stops
 - Automatic Tuning may take up to ½ hour. Remember, while the display point flashes, the controller is autotuning.

Note: If an AT error (AtEr) occurs, the automatic tuning process is aborted due to the system operating in ON-OFF control mode (PB=0). The process will also be aborted if the set point is set too close to the process temperature or if there is insufficient capacity in the system to reach the set point (e.g. inadequate heating power available). Upon completion of auto-tuning the new PID settings are automatically entered into the controller's non-volatile memory.

Manual Mode In the event of a faulty J Sensor, the display will read "SbEr". Entering manual mode will bypass the faulty sensor and allow you to run your dryer manually. Press and hold both the scroll and return key for 6 seconds to enter manual mode. Display on controller will show H000. Press the up or down arrow to set percentage of time the heater will cycle on and off. (i.e. a setting of 80.0 will cycle heater on 80% of time and off 20%). Controller can remain in this mode while resuming production.

Celsius / Fahrenheit The temperature controller on your Vastex Infrared dryer is normally set to Fahrenheit as a default. Follow the procedure below to switch the controller from Fahrenheit to Celsius.

- Press and hold the Scroll Key button for 6 seconds. When you let go, the display will change to "ASPI" and a numerical value will be given.
- Press the Scroll key 6 times to display the letters "td" and a numerical value will be given again.
- Press and hold the Scroll Key for 6 seconds. Release the button and the display will change to "LoCL" and a numerical value given.
- Press the Scroll key 6 times to display the letters "CF". If machine is set to display Fahrenheit, this value will be 0. If the machine is set to Celsius, this value will be "1"
- To change the controller from Fahrenheit to Celsius:**

-Press the Up Key one time to change the displayed number to "1". The display will now read in Celsius.

To change the controller from Celsius to Fahrenheit:

-Press the Down key one time to change the displayed number to "0". The display will now read in Fahrenheit

- Press the Return Key one time to take you back to normal operation

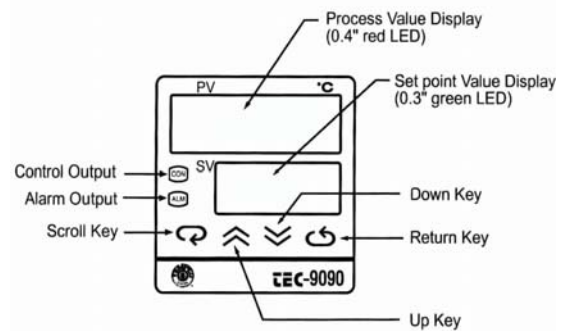

Troubleshooting

Symptom	What to check:
No Heat & power light is off	<ul style="list-style-type: none"> • Incoming power. • Shop Disconnect, Fuses, or breakers. • Power cord and it's connections
No Heat & power light is on	<ul style="list-style-type: none"> • Check for burned out heater • System fuses on control panel • Note operation of pilot lights, Call Vastex
Heat too high	<ul style="list-style-type: none"> • Note operation of pilot lights (Relay can stick on or off)
Heat too low	<ul style="list-style-type: none"> • Note operation of pilot lights (Relay can stick on or off)
Temperature fluctuates	<ul style="list-style-type: none"> • Check sensor location • Clean sensor connections • Eliminate Wind or Draft in shop • Note operation of pilot lights, Call Vastex
Belt Stopped or is erratic	<ul style="list-style-type: none"> • Check plug at motor power cord • Check sprocket and chain • Check output voltage at plug (90VDC) • Check for obstruction in belt path • Check belt tension • Check brushes on motor (Optional HD motor)

Vastex E-mail assistance

Purchasing & Product Info:

sales@vastex.com

Electrical Support:

stech@vastex.com

Tech Support, Mechanical Setup, and Operation

techsupport@vastex.com

Screen Printing Issues & Support:

printech@vastex.com

IMPORTANT READ BEFORE OPERATING DRYER

Restricting the dryers exhaust will effect the operation of the dryer. Excessive heat buildup within the chamber may damage the exhaust blower. Proper venting is important.

EC-II SERIES SINGLE & DOUBLE CHAMBER DRYERS

The Exhaust Hood is an option for all Vastex Dryers

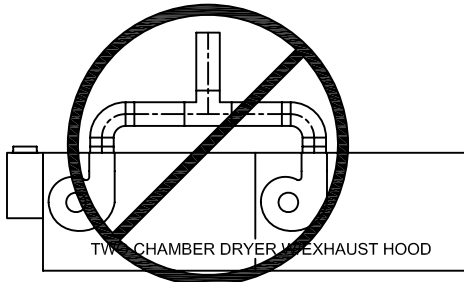

Exhaust blower damage will result
WRONG

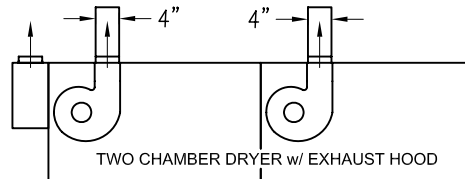

SEPERATE EXHAUST DUCTS
See notes 1 & 2
ACCEPTABLE

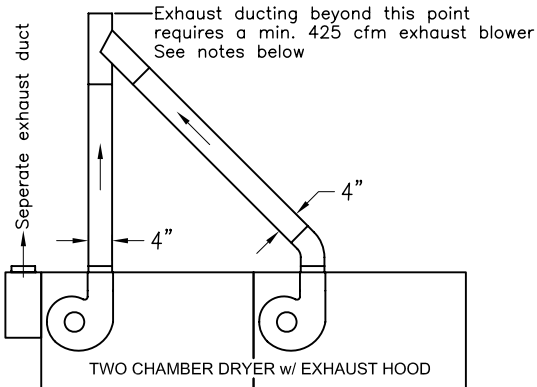

45° TEE WYE DUCTING
Exhaust stack blower is required
See notes 1 & 2
ACCEPTABLE

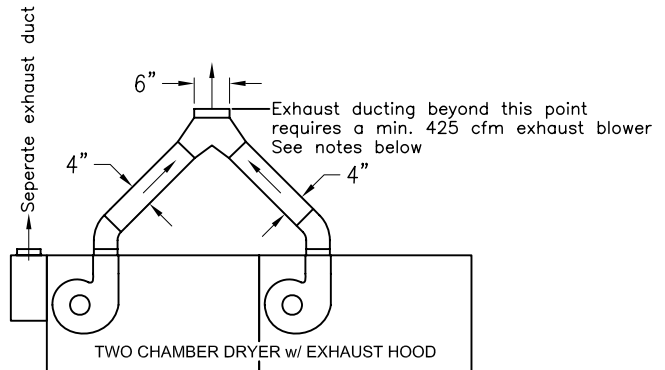

WYE JOINT DUCTING
Exhaust stack blower is required
See notes 1 & 2
PREFERRED

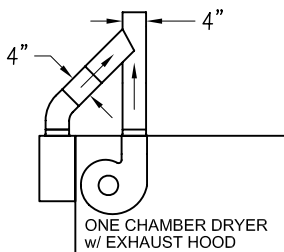

45° TEE WYE DUCTING
See notes 1 & 2
ACCEPTABLE

EC-I & DB SERIES DRYERS

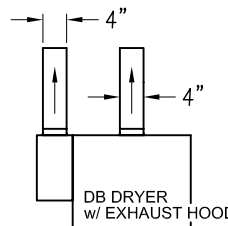

SEPERATE EXHAUST DUCT
See note 1 & 3
ACCEPTABLE

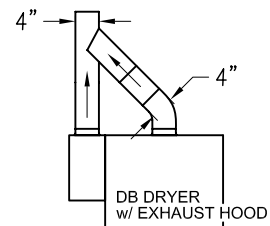

45° TEE WYE DUCTING
See note 1 & 3
PREFERRED

Note:

- 1.) If the exhaust duct length is greater than 6ft. and/or if more than one elbow is used, an exhaust booster is required.
- 2.) EC-II Dyers with exhaust duct lengths greater than 20ft. consult a HVAC installer to determine proper size duct to maintain min. of 425 cfm.
- 3.) DB Dryers with exhaust duct lengths greater than 20ft. consult a HVAC installer to determine proper size duct to maintain min. of 250 cfm.

Vastex Warranty

Doc#01-00-005B Revised 10/15/07

(1.) Vastex, hereinafter referred to as “seller” warrants only to its original “purchaser”, who holds a copy of the original invoice and is the original end user of the equipment in question, its new equipment against defects in materials or workmanship on a pro-rated basis. Warranty period begins from date of shipment to the buyer and will only apply to customers paid in full. Warranty periods are as follows: one (1) year for E-1000, and V-1000, three (3) years for all other equipment (including F-Flash), ten (10) years for infrared heaters (excluding F-Flash) installed by Vastex in a new dryer, three (3) years for replacement infrared heaters, and one (1) year for replacement parts. Rubber blankets, light bulbs and glass on exposure units are particularly subject to wear while in use. Wear is not covered by this warranty but as stated above only manufacturers defects are covered. All sales made through Vastex dealers must be certified by that dealer before a warranty replacement is issued.

(2.) This warranty is expressly contingent upon the buyer delivering to seller, at the address below, with all transportation charges prepaid, the part or parts claimed to be defective within the above mentioned warranty periods stated in paragraph one. The defective part or parts will be repaired or replaced at the discretion of Vastex International, Inc. If the equipment in question is less than one (1) year old, it will be shipped to the customer at no charge, with an RGA issued by Vastex for the defective part. The defective part must be shipped back to Vastex freight prepaid within 30 days or the account will be billed. If the equipment is more than a year old, the part will be shipped after we receive the defective part. If it's necessary to expedite the movement of parts and to minimize down time to the buyer, the replacement part shall be supplied on a C.O.D. basis. If testing and analysis of said part by the seller or its supplier discloses that said part is defective, the cost of said part will be refunded to the buyer on a prorated basis.

(3.) Except as otherwise provided herein, the equipment is being sold “as-is”. Final determination of the suitability of the equipment for the use contemplated by the buyer, is the sole responsibility of buyer, and seller shall have no responsibility in connection with the suitability.

(4.) All warranties implied by law, including the implied warranties of merchantability and fitness are hereby limited to workmanship and defective parts to a warranty period stated in paragraph one. The express warranty and remedies contained herein and such implied limited warranties are made solely to the sole warranties and remedies and are in lieu of all other warranties, guarantees, agreements, and other liabilities, whether express or implied, and all other remedies for breach of warranty or any other liability of seller, in no event shall seller be liable for consequential damages.

No person, agent, distributor, or service representative is authorized to change, modify or extend the terms hereof in any manner whatsoever.

These terms and conditions are an essential part of the transaction between the parties and constitute the entire agreement between them with respect to the same.

Some states do not allow limitation on how long an implied warranty lasts of the exclusion or limitation of incidental, or consequential damages, so the above limitation may not apply to you.

This warranty gives you specific legal rights, and you may also have other rights which vary from state to state.

Infrared heaters are the only replacement parts covered for a period of (3) years from date of shipment and contingent to receipt of payment in full.

Electrical components can not be returned once installed unless proven defective.
Please refer to doc. 01-01-006 for warranty implementation help.
Please refer to doc. 01-00-015 for specific terms and conditions of sale and the limited warranty.
Please refer to doc. 01-00-017 for V-2000HD printer warranty.

F:\Shared\Vastex\01-Manuals & Doc\00-misc\01-00-005B_Warranty.doc

VASTEX WARRANTY IMPLEMENTATION SHEET

Please read this document in order to fully understand the warranty.

Doc.# 01-00-006

Your new Vastex equipment is protected against *manufacturers' defects by our warranty, completely explained in doc# 01-00-017 for the V2000-HD series manual printer and in doc# 01-00-005 for all other Vastex manufactured equipment. Please refer to these documents for the **warranty term and specific concerns about the warranty. The following are some important facts and requirements for the proper implementation of the warranty.

1.0 Everything is covered!

2.0 **Warranty Term is defined as: Ship date from VASTEX to the date the item in question is returned to VASTEX for inspection and repair.

3.0 *Manufacturers defects are defined as: Parts determined to be defective in workmanship which will lead up to a premature failure. The determination will be made only by the manufacturer of the item in question.

4.0 To take advantage of the warranty the following steps must be taken:

- 4.1 The equipment must be paid for in full.
- 4.2 The item in question must be shipped to VASTEX for evaluation with all shipping costs incurred by the buyer.
- 4.3 If the item is deemed as a manufacturer's defect it will be repaired or replaced within 2 business days from the time received. The shipping cost back to the customer located in the continental United States will be paid by VASTEX if a warranty item.
- 4.4 **If the item in question must be replaced immediately and is more than a year old, it will have to be purchased at list price and will be shipped COD. A pro-rated credit will be given promptly if the returned item is a valid manufacturer's defect.**
- 4.5 If the equipment was shipped less than a year before the date of the service call and a technician confirms the part needed for repair, the replacement will be shipped before the replacement is shipped back. An RGA will be issued and must accompany the old part to VASTEX within 30 days or the account will be billed.

5.0 Important facts about the condition of shipped equipment:

- 5.1 Dryers are partially assembled with the belts tracked and the machine run at full temperature for a min. of 1 ½ hours.
- 5.2 Printers are partially assembled, inspected, and adjusted for all heads down prior to partial disassembly and packing.
- 5.3 Exposing units are fully assembled and tested with the maximum screen size for vacuum integrity, timer operation and light output.

6.0 This document is in addition to the standard warranty and only helps the customer understand how to take advantage of the warranty. In no way does this document override the standard warranty or the terms and conditions of sale and the limited warranty doc# 01-00-015.

Please see doc# 01-00-015 for specific terms and conditions of sale and the limited warranty

VASTEX
INTERNATIONAL

1032 N. IRVING ST.
ALLENTOWN PA. 18109 USA

Vastex International, Inc.

TERMS AND CONDITIONS OF SALE AND LIMITED WARRANTY Doc.#01-00-015

1. Buyer's order will constitute an offer in accordance with the terms hereof and such offer, upon acknowledgment of Seller, will constitute the agreement between Buyer and Seller. Buyer's order after such acknowledgment by Seller will not be subject to cancellation, change or reduction in amount, or suspension by Buyer of deliveries, unless prior to such action Buyer has obtained Seller's written consent. Notwithstanding anything to the contrary in Buyer's Purchase Order or other communications, the parties agree to be bound by these Terms and Conditions. Acceptance of the product by the Buyer shall be deemed to constitute unconditional acceptance of these Terms and Conditions.
2. Any of these terms, conditions and provisions of Buyer's order which are inconsistent with Seller's acknowledgment and these Terms and Conditions of Sale shall not be binding on the Seller and shall be considered not applicable to any sale so made. No waiver, alteration or modification of any of the provisions on either side of the document shall be binding upon Seller unless agreed to in writing by Seller.
3. (a) All prices are F.O.B. Seller's Plant and method of delivery and routing shall be at Seller's discretion, unless specifically otherwise stated herein. Notwithstanding any agreement to pay freight, delivery of products purchased hereunder to a common carrier or licensed trucker shall constitute delivery to Buyer and be determinative of the date and time of shipment and all risk of loss or damage in transit shall be borne by Buyer. If the Buyer fails to accept the goods from the common carrier or licensed trucker, the Seller shall be entitled to claim payment from the Buyer. Seller shall arrange for storage, the risk and the cost, including insurance costs, to be borne by the Buyer (and Buyer agrees to pay such amounts upon demand) except if the failure to accept delivery is due to any of the exceptions noted in Paragraph 4.

(b) Terms of payment shall be as stated on invoice.
4. It is understood that deliveries will be made in accordance with Seller's regular production schedule. Every reasonable effort will be made to meet the Buyer's required delivery dates but Seller will not be liable for damages or be deemed to be in default by reason of any failure to deliver or delay in delivery due to any preference, priority, allocation or allotment order issued by the Government, whether Federal, State or local, or causes beyond its control including but not limited to, Acts of God or a public enemy, acts of Government, fires, floods, epidemics, quarantine restrictions, strikes, lockouts, freight embargoes, severe weather, unavailability of materials or shipping space, delays of carriers or suppliers or delays of any subcontractors. Should delay in delivery be caused by any of the circumstances mentioned in this paragraph, such extension of the delivery period shall be granted as is reasonable under the circumstances of the case. Should delay be caused by an event not specifically mentioned in this paragraph, damages will be limited to cancellation of the purchase order without penalty, and refund of any monies deposited or prepaid on the purchase order with no liability for any consequential or incidental damages.
5. Seller reserves the right to increase the prices prior to Seller's acceptance of order and/or after expiration of any price quoted by Seller.
6. Unless otherwise stated in writing, Seller's prices do not include sales, excise, value-added or other taxes. Consequently, in addition to the price specified herein, the amount of any present or future sales, use, excise, value-added or other tax applicable to the manufacture, sale, purchase or use of the products hereunder shall be paid by Buyer, or in lieu thereof, Buyer shall provide Seller with a valid tax exemption certificate acceptable to the taxing authorities.
7. Seller reserves the right, at any time, to revoke any credit extended to Buyer because of Buyer's failure to pay for any products when due or for any other reason deemed good and sufficient by Seller and in such event, all subsequent shipments shall be paid for prior to at delivery at Seller's option.
8. (a) SELLER'S LIABILITY SHALL BE LIMITED TO SELLER'S STATED SELLING PRICE PER UNIT OF ANY DEFECTIVE GOODS AND SHALL IN NO EVENT INCLUDE BUYER'S MANUFACTURING COSTS, LOST PROFITS, GOODWILL, OR ANY OTHER SPECIAL, INDIRECT, INCIDENTAL OR CONSEQUENTIAL DAMAGES, ARISING OUT OF THE AGREEMENT, THIS CONTRACT, THE SALE OF THE PRODUCTS TO THE BUYER OR THE USE OR THE PERFORMANCE OF THE PRODUCTS. Seller may at its discretion repair, replace or give the Buyer credit (pro-rated) for such defective products.

(b) Notwithstanding anything herein to the contrary, Seller shall have no liability for alleged defects with the products which are not specified in written notice from the Buyer to the Seller within thirty-six (36) months from the date of shipment of machines. Seller shall pass to Buyer any warranty received by Seller from the manufacturer of Limited Life Components, which in most cases is 12 to 18 months.

(c) Seller shall have no liability under this Limited Warranty unless Buyer has paid in full for the products. Further, this Limited Warranty is expressly contingent on Buyer's delivery to Seller, all costs prepaid, the defective part(s) within thirty-six (36) months of shipment to Buyer, together with a written statement specifying the alleged defect(s). Any replacement part(s) shall be shipped to Buyer on a C.O.D. basis.

(d) SELLER SPECIFICALLY EXCLUDES ALL WARRANTIES, EXPRESSED, IMPLIED OR OTHERWISE, EXCEPT AS STATED EXPLICITLY IN THESE TERMS AND CONDITIONS OF SALE. SELLER DISCLAIMS THE WARRANTY OF MERCHANTABILITY AND FITNESS FOR A PARTICULAR PURPOSE.
9. The remedies herein reserved by Seller shall be cumulative and in addition to any other legal remedies. No waiver of a breach of any portion of this contract shall constitute a waiver of continuing or future breach of such provision or of any other provisions hereof.
10. These Terms and Conditions constitute the entire agreement of the parties. No amendments, changes, revisions or discharges hereof in whole or in part shall have any force or effect unless set forth in writing and signed by the parties hereto. This contract shall not be assignable by Buyer voluntarily by operation of law or otherwise without Seller's written consent.
11. This contract shall be governed and shall be construed according to the domestic laws of the Commonwealth of Pennsylvania.
12. Anything herein to the contrary notwithstanding, any action for alleged breach by Seller of the contract between the parties, including but not limited to any action for breach of the warranties herein set forth, shall be barred unless commenced by Buyer within one (1) year from the date such cause of action accrued.
13. This agreement shall inure to the benefit of and be binding upon the parties hereto, their respective successors and permitted assigns.
14. **All notices required by this contract to be given by either party shall be sent in writing or by facsimile and shall be addressed to the last known address of such other party. Notices shall be deemed to have been received on the fifth business day following deposit in the mail.**